



MODEL 1700 LIQUID LEVEL INSTRUMENT

(HELIUM & NITROGEN VERSION)

**INSTALLATION, OPERATION, AND
MAINTENANCE INSTRUCTIONS**

American Magnetics, Inc.

P.O. Box 2509, 112 Flint Road, Oak Ridge, TN 37831-2509, Tel: 865-482-1056, Fax: 865-482-5472

Foreword vii

Purpose and Scope vii

Contents of this Manual vii

General Precautions viii

Cryogen Safety Summary x

Safety Legend x

Equipment Warnings xi

Other Manual Conventions xi

Instrument Configuration xii

Introduction 1

Model 1700 Instrument 1

 Cryogenic (Capacitance-Based) Liquid Level Sensors 1

 Superconducting Level Sensors 3

 Digitally-Controlled 3

 System Flexibility 3

 Display 4

 Intuitive Human-Interface Design 4

 Measurement Flexibility 4

 Real Time Clock 4

 Valve Control Output 4

 Analog Outputs 4

 Signal Relays 4

 Connectivity 5

Model 1700 Front Panel Layout 6

Model 1700 Rear Panel Layout 7

Model 1700 Specifications @ 25°C 8

Installation 11

Unpacking and Inspecting the Instrument 11

Mounting the Model 1700 Instrument 11

Capacitance-Based Liquid Level Sensor Installation	12
Liquid Helium Level Sensor Installation	13
Connecting the Sensors to the Instrument	14
Connecting a Capacitance Sensor	14
Connecting a Liquid Helium Level Sensor	15
Setting Up an Autofill System	17
Autofill System Description	17
Autofill System Setup	18
Power Requirements	20
0-10 VDC Recorder Output	20
4-20 mA Current Loop Output	20
Operation	23
Energizing the Model 1700 Instrument	23
Screen Navigation	25
Home Screen Footer	25
Navigating the Instrument Menus	25
Menu Overview	26
Editing a Field	29
Menu Navigation	30
Capacitance (Liquid nitrogen) Level	31
Configure the instrument to display nitrogen level	31
Superconducting (Liquid Helium) Level	31
Configure the instrument to display helium level	31
Sensor Burnout Protection	34
Sample and Hold Operation	34
Other Liquid Helium Functions	35
Alarms and Relays	36
Level-Based Alarms	36
Time-Based Fill Alarm (nitrogen only)	36
Multiple alarms	37
Configuring Alarm Setpoints	37
Acknowledging an Alarm	38
Muting an Alarm	39

Resetting the Autofill Timeout Alarm	39
Configure the Autofill Function	39
Setting the autofill parameters	39
Enable the Autofill function	41
Select the appropriate units on the display	41
Analog output signals	42
Configuring the Analog Outputs	42
Ethernet Connectivity	42
IP Addressing Scheme	42
Abnormal Operation	43
Capacitance Sensor Contamination	43
Dirty Helium Sensor Operational Mode	44
Resetting the Instrument to Factory Defaults	44
Shutting the Instrument Down	45
Calibration	47
Setting the System Date and Time	47
Capacitance-based Level Calibration	48
Understanding the Sensor Active Length	48
Relationship between Calibration and Sensor Length	50
Variations in the Dielectric with Changing Density	50
Capacitance-based Sensor Calibration Methods	51
Pre-Calibration Procedure	54
Performing an Open Dewar Calibration	57
Closed Dewar Calibration	59
Approximate Calibration	64
Superconductivity-Based (Liquid Helium) Level Calibration	68
Verify the Liquid Helium Sensor Type	68
Sensor Sample Interval	69
Sensor Active Length	70
Continuous Measure Time Limit	70
Sensor Name	71

Remote Interface Reference..... 73

SCPI Command Summary 73

RS-232 Configuration 77

 Serial port connector and cabling 78

 Command/return termination characters..... 78

Ethernet Configuration 78

 Ethernet Connector..... 79

 Termination Characters..... 79

 Port Assignment 79

Command Reference 80

 System Related Commands 80

 Display Configuration Commands and Queries 82

 Alarm Configuration Commands and Queries 83

 Measurement Commands and Queries 84

 Fill Control and Queries 85

 HE Channel Sampling Commands and Queries..... 86

 Assignment Commands and Queries 87

 N2 Channel Calibration Commands and Queries..... 87

 HE Channel Calibration Commands and Queries..... 88

 Remote Units Commands and Queries 88

Error Codes 89

Service and Repair 91

Cleaning 91

User Replaceable Parts 91

Battery Replacement..... 92

 Tools Required 92

 Procedure 92

Fuse Replacement..... 93

 Tools Required 93

 Procedure 93

Firmware Upgrade Via Micro-SD Card Replacement 94

 Tools Required 94

 Procedure 94

Appendix..... 97

Serial (RS-232) Connector..... 97

Ethernet Connector 98

Liquid Helium Connector J1 Wiring..... 99

Aux I/O Connector 100

Dielectric Constants for Cryogenic Liquids 101

Troubleshooting..... 102

 Instrument Displays “LOSS OF SENSOR” Condition for LN2 Level Measurement 102

 Instrument Displays “LOSS OF SENSOR” Condition for LHe Level Measurement 102

 Instrument Displays “SENSOR SHORTED” Condition for LN2 Level Measurement 102

 Instrument Displays “SENSOR PROTECTED” Condition for LHe Measurement 103

Firmware Licenses..... 104

Asco Solenoid-Operated Flow Valve Data Sheet 111

Glossary 117

Abbreviations and Acronyms..... 117

Index..... 119

FOREWORD

PURPOSE AND SCOPE

This manual contains the operation and maintenance instructions for the American Magnetics, Inc. Model 1700 Liquid Level Control Instrument and outlines applications for various system configurations. Since it is not possible to cover all equipment combinations for all magnet systems, only the most common configurations are discussed. The user is encouraged to contact an authorized AMI Technical Support Representative for information regarding specific configurations not explicitly covered in this manual. This manual refers to the instrument as configured for both liquid nitrogen and liquid helium operation.

CONTENTS OF THIS MANUAL

Introduction describes the functions, specifications, and characteristics of the Model 1700 Instrument. It provides illustrations of the front and rear panel layouts as well as documenting the performance specifications. Additional information is provided in the form of system block diagrams.

Installation describes how the Model 1700 Instrument is unpacked and installed in conjunction with ancillary equipment in typical systems. Block-level diagrams document the interconnects for various system configurations.

Operation describes how the Model 1700 Instrument is used to monitor and automatically control liquid nitrogen level and/or monitor liquid helium level.

Calibration describes the various calibration techniques for liquid helium and liquid nitrogen level sensors.

Remote Interface Reference documents all remote commands and queries available through the Model 1700 Instrument RS-232 and Ethernet interfaces. A quick-reference summary of commands is provided as well as a detailed description of each.

The **Appendix** and **Glossary** sections support the information in the sections listed above. See the Appendix section when referenced from other sections. See the Glossary for any words or acronyms presented in the above sections, requiring a more complete understanding.

GENERAL PRECAUTIONS

Cryogen Safety

The two most common cryogenic liquids used in superconducting magnet systems are nitrogen and helium. Both of these cryogens are extremely cold at atmospheric pressure (-321°F and -452°F , respectively). The following paragraphs outline safe handling precautions for these liquids.

Personnel handling cryogenic liquids should be thoroughly instructed and trained as to the nature of the liquids. Training is essential to minimize accidental spilling. Due to the low temperature of these materials, a cryogen spilled on many objects or surfaces may damage the surface or cause the object to shatter, often in an explosive manner.

Inert gases released into a confined or inadequately ventilated space can displace sufficient oxygen to make the local atmosphere incapable of sustaining life. Liquefied gases are potentially extreme suffocation hazards since a small amount of liquid will vaporize and yield a very large volume of oxygen-displacing gas. Always ensure the location where the cryogen is used is well ventilated. Breathing air with insufficient oxygen content may cause unconsciousness without warning. If a space is suspect, purge the space completely with air and test before entry. If this is not possible, wear a forced-air respirator and enter only with a co-worker standing by wearing a forced-air respirator.

Cryogenic liquids, due to their extremely low temperatures, will also burn the skin in a similar manner as would hot liquids. Never permit cryogenic liquids to come into contact with the skin or allow liquid nitrogen to soak clothing. Serious burns may result from careless handling. Never touch uninsulated pipes or vessels containing cryogenic liquids. Flesh will stick to extremely cold materials. Even nonmetallic materials are dangerous to touch at low temperatures. The vapors expelled during the venting

process are sufficiently cold to burn flesh or freeze optic tissues. Insulated gloves should be used to prevent frost-bite when operating valves on cryogenic tanks. Be cautious with valves on cryogenic systems; the temperature extremes they are typically subjected to cause seals to fail frequently.

In the event a person is burned by a cryogen or material cooled to cryogenic temperatures, the following first aid treatment should be given pending the arrival and treatment of a physician or other medical care worker:

1. If any cryogenic liquid contacts the skin or eyes, immediately flush the affected area gently with tepid water (102°F – 105°F, 38.9°C – 40.5°C) and then apply cold compresses.
2. Do not apply heat. Loosen any clothing that may restrict circulation. Apply a sterile protective dressing to the affected area.
3. If the skin is blistered or there is any chance that the eyes have been affected, get the patient immediately to a physician for treatment.

Containers of cryogenic liquids are self pressurizing (as the liquid boils off, vapor pressure increases). Hoses or lines used to transfer these liquids should never be sealed at both ends (i.e. by closing valves at both ends).

When pouring cryogenic liquids from one container to another, the receiving container should be cooled gradually to prevent damage by thermal shock. The liquid should be poured slowly to avoid spattering due to rapid boil off. The receiving vessel should be vented during the transfer.

Introduction of a substance at or near room temperature into a cryogenic liquid should be done with great caution. There may be a violent gas boil-off and a considerable amount of splashing as a result of this rapid boiling. There is also a chance that the material may crack or catastrophically fail due to forces caused by large differences in thermal contraction of different regions of the material. Personnel engaged in this type of activity should be instructed concerning this hazard and should always wear a full face shield and protective clothing. If severe spraying or splashing could occur, safety glasses or chemical goggles along with body length protective aprons will provide additional protection.

The properties of many materials at extremely low temperatures may be quite different from the properties that these same materials exhibit at room temperatures. Exercise extreme care when handling materials cooled to cryogenic temperatures until the properties of these materials under these conditions are known.

Metals to be used for use in cryogenic equipment application must possess sufficient physical properties at these low temperatures. Since

ordinary carbon steels, and to somewhat a lesser extent, alloy steels, lose much of their ductility at low temperatures, they are considered unsatisfactory and sometimes unsafe for these applications. The austenitic Ni-Cr alloys exhibit good ductility at these low temperatures and the most widely used is 18-8 stainless steel. Copper, Monel[®], brass and aluminum are also considered satisfactory materials for cryogenic service.

CRYOGEN SAFETY SUMMARY

Cryogenic systems are complex systems with the potential to seriously injure personnel or equipment if not operated according to procedures. The use of safety mechanisms (pressure relief valves, rupture disks, etc.) in cryogenic systems is usually necessary.

Recommended Safety Equipment

The use of proper safety equipment is necessary. Such equipment may include, but not limited to, the following items:

- First Aid kit
- Fire extinguisher rated for class C fires
- Cryogenic gloves
- Face shield
- Signs to indicate that there are potentially dangerous cryogenics in use in the area.

SAFETY LEGEND



Instruction manual symbol: the product is marked with this symbol when it is necessary for you to refer to the instruction manual in order to protect against damage to the product or personal injury.



Hazardous voltage symbol.



Alternating Current (Refer to IEC 417, No. 5032).



Off (Supply) (Refer to IEC 417, No. 5008).



On (Supply) (Refer to IEC 417, No. 5007).

WARNING The Warning sign denotes a hazard. It calls attention to a procedure or practice, which if not correctly adhered to, could result in personal injury. Do not proceed beyond a Warning sign until the indicated conditions are fully understood and met.

CAUTION The Caution sign denotes a hazard. It calls attention to an operating procedure or practice, which if not adhered to, could cause damage or destruction of a part or all of the product. Do not proceed beyond a Caution sign until the indicated conditions are fully understood and met.

EQUIPMENT WARNINGS

Before energizing the equipment, the earth ground of the power receptacle must be verified to be at earth potential and able to carry the rated current of the power circuit. Using extension cords should be avoided. However, if an extension cord must be used, insure the ground conductor is intact and the cord is capable of carrying the rated current without excessive voltage drop.

In the event that the ground path becomes less than sufficient to carry the rated current of the power circuit, the equipment should be disconnected from power, labeled as unsafe, and removed from place of operation.

Do not operate this equipment in the presence of flammable gases. Doing so could result in a life-threatening explosion.

Do not modify this equipment in any way. If component replacement is required, return the equipment to AMI facilities as described in the troubleshooting section of this manual.

If used in a manner not specified in this manual, the protection provided by the design, manufacture and documentation of the Model 1700 Instrument may be impaired.

OTHER MANUAL CONVENTIONS

This manual refers to measuring liquid nitrogen (LN₂) when referring to capacitance-based level measurement since nitrogen is by far the most common cryogenic fluid used by this sort of instrument. This instrument can be used to measure most any cryogenic liquid.

INSTRUMENT CONFIGURATION

The Model 1700 Instrument is configured at time of purchase in several ways:

- As a capacitance-based (typically liquid nitrogen) level instrument/controller.
- As a helium level instrument for level sensors with active length up to 80 inches (203 cm) for either 4.2K or 2K LHe.
- As a combination nitrogen and helium instrument/controller. Note that there is only one control channel even though the instrument can simultaneously display both liquid levels.

Every configuration may be further customized by the following options:

- Table top, single rack mounting, dual rack mounting.
- Line cord: North American, European Schuko, Australia/NZ, China, UK, pig-tailed ends.

The instrument part number, shown on the serialization label located on the underside of the instrument, as well as in a field in the instrument Menu, identifies the configuration according to the following key:

1700-A-B-C-D-E where

A indicates the mounting method:

Tbl = tabletop

SR19L = single rack mounted, 19" wide rack standard, instrument on left side

SR19R = single rack mounted, 19" wide rack standard, instrument on right side

SR10L = single rack mounted, 10" wide rack standard, instrument on left side

SR10R = single rack mounted, 10" wide rack standard, instrument on right side

DRL = dual rack mount, 19" wide rack standard, instrument on left side

DRR = dual rack mount, 19" wide rack standard, instrument on right side

B indicates the line cord shipped with the instrument:

N = North American

E = European, Schuko

A = Australian/New Zealand

C = Chinese

U = United Kingdom

P = India/pigtailed

C indicates the capacitance-based level configuration:

CAP = capacitance-based (typically nitrogen)

N = not configured

The sensor active length and length units are appended to the configuration code, ie ...CAP-10.4CM-...

D indicates the helium level configuration:

He2K = 2K helium for sensors

He4K = 4.2K helium for sensors

N = not configured

The sensor active length and length units are appended to the configuration code, ie ...He2K-40IN-...

E is used to denote any instrument customization:

S = standard (no customization)

C = instrument modified.

INTRODUCTION

MODEL 1700 INSTRUMENT

The AMI Model 1700 Liquid Level Instrument is a sophisticated measurement and control instrument which provides monitoring liquid helium and/or capacitance-based level sensors as inputs and provides for automatic level control based on user set parameters.

At time of purchase, the Model 1700 will be configured as:

- A combination capacitance-based and helium level instrument/controller. Note that there is only one valve control channel (typically used for nitrogen auto fill systems) but both liquid levels can be displayed simultaneously.

The Model 1700 instrument will measure liquid helium level using a superconducting level sensor. The instrument will be factory configured for either 4.2K or 2K liquid helium level sensors at time of purchase.

CRYOGENIC (CAPACITANCE-BASED) LIQUID LEVEL SENSORS

The Model 1700 Instrument will be used with a capacitance-based sensor for all cryogenic liquids except for helium. Special insulated capacitance sensors are required for liquids with electrical conductivity, i.e. water.

The Model 1700 Instrument must use an oscillator device to measure cryogenic liquid levels. This instrument has an internal oscillator if the distance between the sensor and the instrument is less than or equal to 15 feet (457 cm) so no external oscillator is necessary. If the distance between the sensor and the instrument is greater than 15 feet, an external oscillator/transmitter unit is necessary. The instrument will automatically configure itself to use the internal oscillator unless the external oscillator/transmitter is connected to the BNC connector on the rear panel.

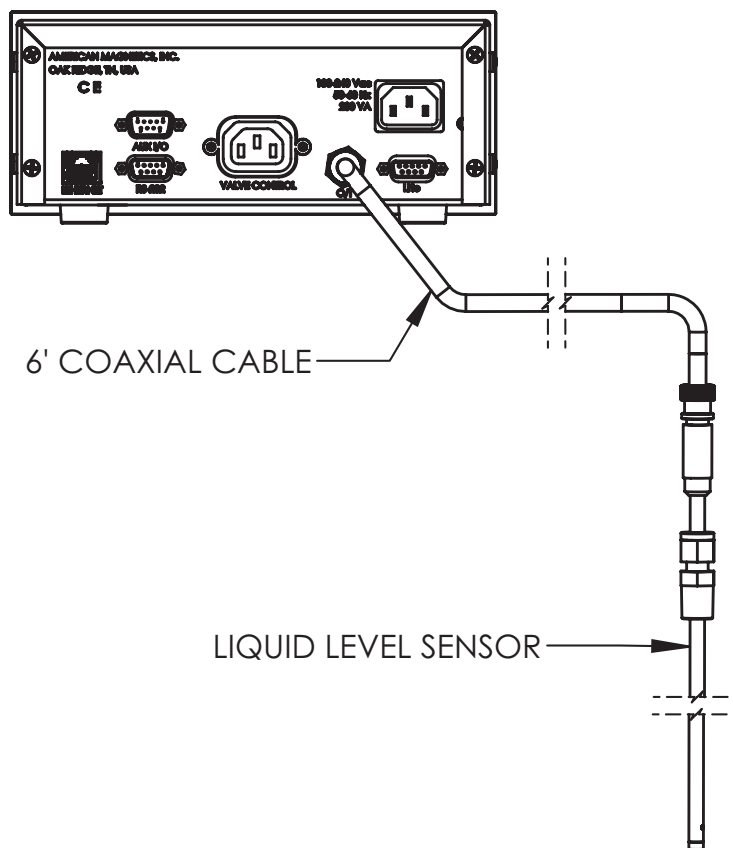

Model 1700 Instrument using internal oscillator/transmitter

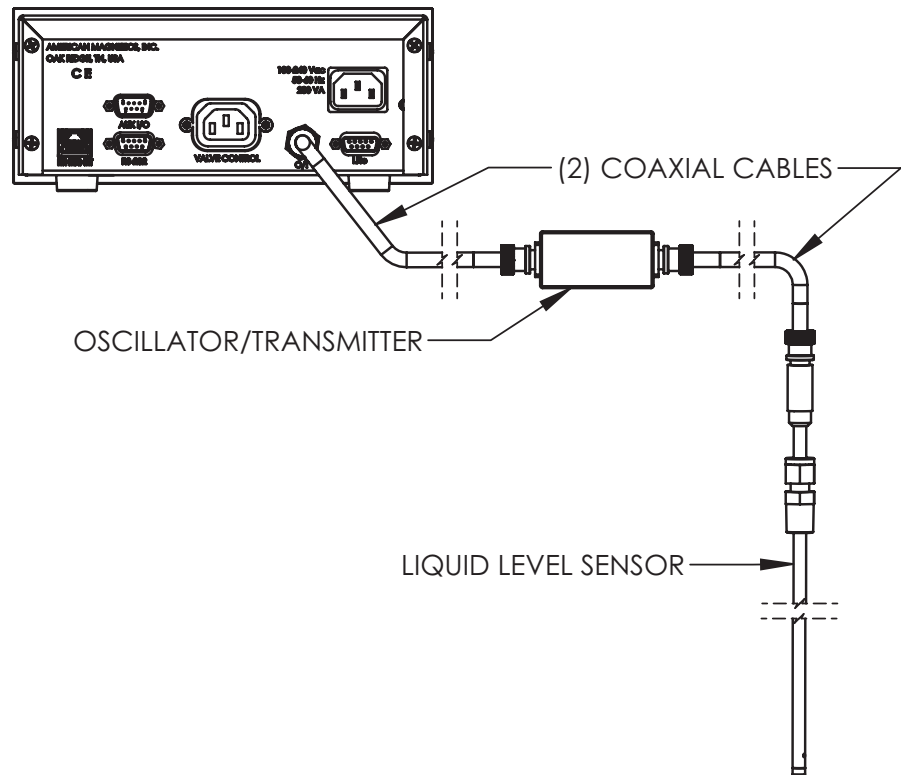

Model 1700 Instrument using external oscillator/transmitter

SUPERCONDUCTING LEVEL SENSORS

The instrument can be used with a superconducting level sensor to measure liquid helium levels. The instrument will be configured at the factory to measure liquid helium levels. The instrument is configured for level sensors of active lengths of 1 - 80 inches. The instrument can be used with either 4.2K or 2K level sensor types but must be configured and calibrated at time of purchase for the LHe level sensor type.

DIGITALLY- CONTROLLED

The Model 1700 contains a microcomputer which controls analog data conversion, display/keypad functions, communications I/O, dry contact closures, generation of analog output signals and relay control of a mains power outlet for solenoid valve autofill applications.

SYSTEM FLEXIBILITY

The Model 1700 instrument incorporates data converters to translate signals between the analog and digital domains. Precision instrumentation techniques and potentiometer-free designs are employed throughout the Model 1700 Instrument to ensure long term stability and accurate signal translation for a wide range of conditions.

DISPLAY

The Model 1700 Instrument has a 4.3" diagonal measure TFT (Thin Film Transistor) color liquid crystal display of 480 x 272 pixels. The display has a 4-wire resistive touch overlay for easy operator input.

**INTUITIVE HUMAN-
INTERFACE DESIGN**

The Model 1700 instrument is designed to simplify the touch-screen based user interface. All functions were analyzed and subsequently programmed so that the most commonly used functions are addressed with the least number of keystrokes. The menus are presented in a logical fashion so that the operation of the Model 1700 is intuitive to the user.

**MEASUREMENT
FLEXIBILITY**

Depending on the instrument version purchased, the Model 1700 can be configured to monitor and display one capacitance-based liquid level sensor (LN₂ version) or one liquid helium level sensor (LHe version) or both simultaneously. Set points can be assigned to control two dry-contact relay outputs. The make or break function of each relay can be set independently. A solid-state relay allows mains power to be switched according to set points to operate a solenoid-operated valve or other load.

REAL TIME CLOCK

The Model 1700 Instrument incorporates a real time clock with automatic daylight savings time adjustment (if desired).

**VALVE CONTROL
OUTPUT**

The Model 1700 Instrument has a switched 2 ampere at mains voltage output for energizing a solenoid operated flow valve or other loads. This outputs is controlled by a zero-crossing solid state relay.

The fill start is triggered by a level reading. The fill is stopped by reaching a user-set level, or exceeding a maximum fill time.

ANALOG OUTPUTS

The Model 1700 Instrument has two analog outputs, a 0-10 V_{DC} voltage output and a 4-20 mA_{DC} current loop output. The 4-20 mA_{DC} loop output has 1500 V_{PK} circuit isolation. The outputs can be used simultaneously. The sources for either of the analog outputs can be either one of the two configured sensors. Both outputs can be driven from the same source, if desired.

SIGNAL RELAYS

The Model 1700 Instrument has two signal relays that change state based on a measured input. The set points of these relays are user-selectable as is their function, alarm on level above or below set point. For the dual channel instrument, both relays can be assigned to either

channel. For the single channel instrument, both relays are assigned to the only channel.

CONNECTIVITY

The Model 1700 Instrument has a 10Base-T Ethernet connection as well as a 115,200 baud RS-232 port for connecting to other equipment. The instrument communicates with a SCPI-based command set. The command set is 100% backward compatible with the AMI Model 135, 136, 185, and 186 instruments when configured as a single channel instrument. When configured as a dual channel instrument, additional commands are incorporated into the command set.

The Model 1700 Instrument allows for remote operation with an external browser via TCP/IP connection. All commands that are available by touching the local screen are available via the web browser

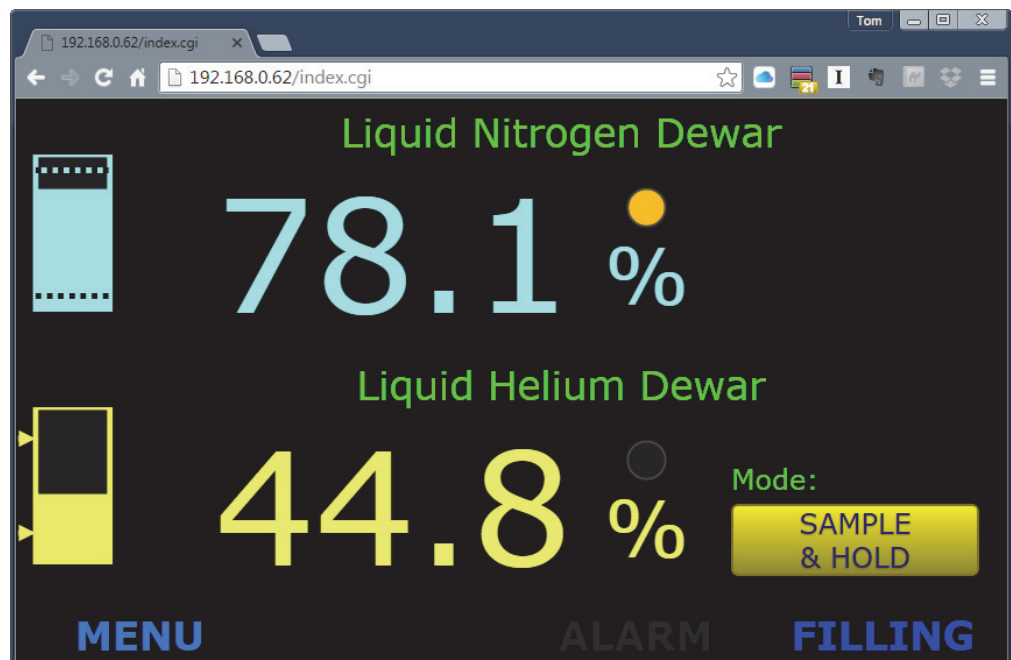

Model 1700 (Dual Display) Via Web Browser

NOTE Using a web browser to connect to the instrument allows different browser sessions to display different information. For instance, one browser window can display helium level only and a second browser window can display nitrogen level only. The instrument can be configured independently as well since it's display is also a browser. Refer to "Configure the instrument to display nitrogen level" on page 31. Refer to "Configure the instrument to display helium level" on page 31.

MODEL 1700 FRONT PANEL LAYOUT



Model 1700 Front View; Dual Channel Instrument Shown

MODEL 1700 REAR PANEL LAYOUT

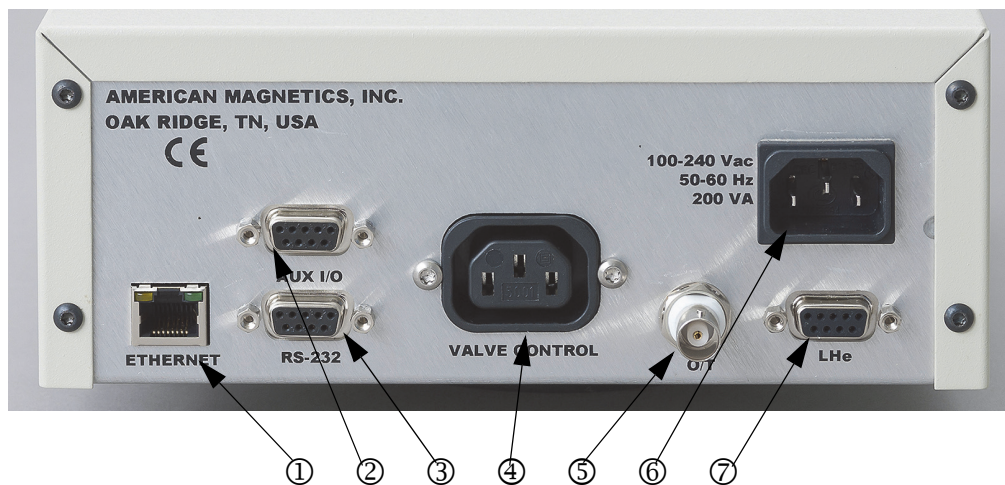

Model 1700 Rear Panel Description

	1 Computer Network Connector
	2 Aux I/O Connector
	3 RS-232 Serial Connector
	4 Switched Valve Outlet Socket
LN2 VERSION	5 Capacitive Sensor Input Connector
	6 Mains Power Entry Connector
LHe OPTION	7 LHe Level Sensor Connector

MODEL 1700 SPECIFICATIONS @ 25°C

System Architecture

Display:	4.3" 24-bit color TFT display, 480x272 pixel with resistive touch screen
Sensor Types:	Capacitance-based liquid level Superconductivity-based liquid level
Maximum Length Readout:	Capacitance-based liquid level up to 999 in Superconductivity-based liquid level (LHe) up to 80 in
Superconducting (LHe) Sensor Excitation:	Continuous reading or Sample and Hold mode
System Operating Firmware Storage:	Flash memory
System Clock:	Real time clock with automatic DST adjustment
Display Measurement Units:	Liquid level in cm, in or percent

Level Measurement

Resolution:	0.1%, 0.1 cm, 0.1 in
Accuracy:	±0.5% of active sensor length
Linearity:	±0.1% or 1 mm (whichever is greater)
Capacitance Sensor Excitation Voltage:	5 V _{DC}
Capacitance Transmitter Measurement Resolution:	0.7 pF
Superconducting LHe Sensor Current:	4.2K LHe Temperature: 75 mA _{DC} nominal 2K LHe Temperature: 57 mA _{DC} nominal
Dirty Sensor Mode:	Approximately twice normal current for 1 second prior to normal measurement excitation
Superconducting LHe Sensor Voltage:	4.2K Sensor: approximately 0.87 V _{DC} per inch of sensor active length @ 10K 2K Sensor: approximately 0.66 V _{DC} per inch of sensor active length @ 10K
Maximum Open Circuit Voltage:	96 V _{DC} , galvanically isolated

Operating Parameters

Alarm Set Points:	0% to 100%, adjustable; Alarm condition settable to above or below set point; Assignable to any channel as high or low alarm for dual instrument
Controller Output:	Line voltage @ 2 A _{AC} (maximum)
Sample and Hold Period:	1 second to 86,400 seconds (24 hrs)
Audible alarm:	3500 ± 500 Hz, 73 to 86 dB(A)

Analog Outputs

Output Types:	0-10 V _{DC} and simultaneous 4 - 20 mA _{DC} ; Each assignable to either level channel for dual instrument
---------------	--

4-20 mA Current Loop Power Supply Voltage:	12-32 V _{DC}
0-10 V _{DC} Recorder Output Load:	50k ohms or greater
0-10 V _{DC} Recorder Output 0% Max Offset:	+20 mV
0-10 V _{DC} Recorder Output 100% Max Error:	± 80 mV
Voltage and Current Output Converter Resolution:	12 bits
Integral Non-linearity:	±1LSB
Differential Non-linearity ^a :	±1LSB

Relays

№1 and/or №2 (W171DIP-7, or equivalent):	Contact Form: 1 Form A (SPST-NO) Maximum Switched Power: 0.29 W Maximum Switched Current: 3 A Switching Voltage: 60 V _{AC} / 100 V _{DC}
Level Control:	Rated Load Voltage: 2 A at 100 to 240 V _{AC} Load Voltage Range: 75 to 264 V _{AC} (Line Dependent) Load Current: 0.1 to 2 A Surge Current: 30 A (60 Hz, 1 cycle)

Auto Fill

Controller Output Socket:	IEC 60320-13 socket on rear panel
Controller Output Power:	2 A _{AC} at line voltage
Autofill Start/Stop Triggering:	Level-based; 0% to 100%, adjustable; Assignable to either nitrogen or helium channel
Fill Timeout Period:	1 minute to 99 hours, 59 minutes
Fill Error Alarm:	Fill time out

Communication Protocol

Host Computer Network Protocol:	10Base-T TCP/IP and RS-232 115,200 baud
IP Addressing:	DHCP or static, IPv4
Network Connectivity and Traffic Indication:	Link and Activity LEDs on instrument rear panel
RS-232 Connector Specifications:	9-pin D-sub female connector to connect standard DTE 9-pin D-sub male connector using a standard straight cable
Communication Command Set:	SCPI-based.

Power Requirements

Primary:	100-240 ±10% V _{AC} , 50-60 Hz, 2.2 A maximum (200 VA plus sum of controller output)
Backup Battery for RTC:	CR2032

Physical

Dimensions ^b :	Table top configuration: 3.8" H x 8.4" W x 11.4" D [97 mm H x 213 mm W x 290 mm D] Single rack mount configuration: 3.5" H x 19.0" W x 11.4" D [89 mm H x 483 mm W x 290 mm D]
Weight:	Table-top configuration: 3.3 lbm [1.5 kg]; Single rack-mount configuration: 4.0 lbm [1.8 kg]

Environmental Limits

Ambient Temperature:	Operating: 0°C to 40°C [32°F to 104°F]; Non-operating: -20 °C to 60 °C [-4 °F to 140 °F]
Relative Humidity:	0 to 95%; non-condensing
Maximum Instrument Background Field:	Gauss (TBD)

Standards

Test Standards	Testing of Equipment for Measurement, Control, and Laboratory Use (IEC 61326-1:2012, EN 61326-1) Electrostatic Discharge (ESD) (EN 61000-4-2) Radiated Immunity (EN 61000-4-3) Fast Transient Burst (EN 61000-4-4) Surges (EN 61000-4-5) Conducted Immunity (EN 61000-4-6) Power Frequency Magnetic Field (EN 61000-4-8) Voltage Dips and Interrupts (EN 61000-4-11) Harmonics (EN 61000-3-2) Flicker (EN 6100-3-3) Conducted Emissions (EN 55011/IEC/CISPR 11) Radiated Emissions (EN 55011/IEC/CISPR 11) Safety Requirements for Electrical Equipment for Measurement, Control, and Laboratory Use (IEC 61010-1)
----------------	--

a. Guaranteed monotonic over operating temperature range
b. H = height; W = width; D = depth

INSTALLATION

WARNING Equipment warnings apply to all system installation configurations. Refer to “Equipment Warnings” on page xi, in the Foreword to be familiar with the safety requirements for a system installation.

UNPACKING AND INSPECTING THE INSTRUMENT

Carefully remove the equipment, interconnecting cabling, and documentation CD (and/or printed material) from the shipping carton, and remove all packaging material.

NOTE If there is any shipping damage, save all packing material and contact the shipping company representative to file a damage claim. Do not return to AMI unless prior authorization has been received.

MOUNTING THE MODEL 1700 INSTRUMENT

If the Model 1700 Instrument is to be used as a table top model, place the equipment on a flat, secure surface.

If the Model 1700 Instrument is to be rack mounted, install it in a 19" wide instrument rack using the mounting hardware supplied by the rack cabinet manufacturer. The feet on the bottom of the instrument may be removed to facilitate rack mounting. Secure the front panel to the rack rail in each of the four corners.

CAPACITANCE-BASED LIQUID LEVEL SENSOR INSTALLATION

Refer to the installation instructions provided with the level sensor(s). The following steps are general installation notes and should be used to supplement the installation instructions provided with the sensor.

Exercise care when installing the capacitance sensor since dents, crimps, bends or other physical distortions in the cylindrical capacitor will change electrical characteristics, possibly causing calibration errors and/or disruption of proper instrument operation. Before installing the sensor, review “Calibration” on page 47 to determine what, if any, calibration procedures may be necessary prior to operation.

NOTE The coaxial interconnecting cables and the transmitter should be mounted in such a manner as to avoid large temperature changes such as those encountered in the path of dewar vents.

1. Carefully remove the sensor from the shipping container and remove all packaging material.

NOTE If there is any shipping damage, save all packing material and contact the shipping representative to file a damage claim. Do not return the instrument to AMI unless prior authorization has been received.

2. Install the sensor in the vessel using the specified fitting of the sensor.

CAUTION Ensure the sensor is mounted with the top vent hole located inside of the cryostat.

CAUTION Avoid installing in a location where icing may occur. Ice formations or moisture buildup on the BNC connector may cause the sensor to short out indicating a higher liquid level than actually exists.

CAUTION Moisture or contaminants in any of the BNC coaxial connectors can short out the sensor and cause measurement errors. A pack of non-conductive electrical connection lubricant (ECL or “Dielectric Tune-up Grease”) has been included with the liquid level sensor packaging to reduce the possibility of this occurring. If desired, apply a small amount of ECL to any of the BNC connectors that may be exposed to moisture. Mate the ECL-coated connectors

then remove any excess ECL from the outside of the connector. Added protection can be achieved by covering the ECL-coated connections with a short section of heat-shrink tubing.

MSDS sheets for the ECL are available upon request.

CAUTION

Exercise care when installing the sensor since dents, crimps, bends or other physical distortions in the thin wall capacitor will change electrical characteristics possibly causing calibration errors and/or disruption of proper instrument operation.

LIQUID HELIUM LEVEL SENSOR INSTALLATION

1. The sensor must be mounted with the electrical leads at the top.
2. For minimum losses, mount the liquid helium sensor so that warm helium gas rising from the sensor can pass directly out of the dewar without contacting surfaces at 4.2K.
3. Do not mount the sensor in restricted areas (tubes, etc.) where the liquid level around the sensor might be depressed by pressure differences in the gas. Do not cover the holes in the sensor.
4. The sensor may be mounted by taping or clipping it to an appropriate support structure. Do not exert excess pressure on the sensor with the mounting device to avoid crushing the tube. Avoid constraining both ends of the sensor and allow for contraction of the sensor during cooldown.

CAUTION

Do not operate the sensor in a vacuum. Operating the sensor in a vacuum may cause thermal damage and/or destruction of the superconducting filament sensor. Do not inadvertently turn the instrument on with the sensor in an evacuated chamber. Operation in pumped liquid helium environments is acceptable to 1K as long as liquid helium is present.

5. Avoid installing in a location where icing (frozen water or gas) may occur since ice formations may cause erratic operation. Ice formation on the NbTi filament may stop the propagation of the normal (resistive) zone before it actually reaches the liquid/gas interface. This will give an indication of a higher helium level than actually exists.

- Connect the sensor to the Model 1700 LHe Level Sensor connector on the instrument rear panel (refer to “Liquid Helium Connector J1 Wiring” on page 99). The liquid helium level sensor leads are color coded:

LHe Level Sensor Wire Identification

Wire Function	Teflon Insulation Color	Formvar Insulation Color	Instrument Connector Pin
I+	Red	Red	1
V+	Blue	Green	8
V-	Yellow	Natural	6
I-	Black	Blue	7

CONNECTING THE SENSORS TO THE INSTRUMENT

CONNECTING A CAPACITANCE SENSOR

The capacitance sensor may be connected directly to the BNC connector on the instrument rear panel if the length of the coaxial cable is 15 feet or less. If the sensor is greater than 15 feet from the instrument, an external oscillator/transmitter unit must be used. Refer to figures “Model 1700 Instrument using internal oscillator/transmitter” on page 2 and “Model 1700 Instrument using external oscillator/transmitter” on page 3 as appropriate.

If the transmitter is connected to the sensor with a length of coaxial cable, the a 15 ft standard length cable, with part number of EH2362, is available from AMI. Contact the factory for details. Speak to an AMI Sales Engineer before using cables longer than 15 feet.

NOTE Regarding the coaxial cable is used to connect the capacitance level sensor to the instrument or oscillator/transmitter, in order to maintain system performance and accuracy, the cable must be Trompeter TCC-75-2 or equivalent and should not be longer than 15 feet [4.57 m]. If a longer length section of coaxial cable is necessary, please discuss with an Authorized AMI Technical Representative.

NOTE If an oscillator/transmitter is used, the length of coaxial cable between the oscillator/transmitter and the instrument may be up to 500 feet in length.

CAUTION

Moisture or contaminants in any of the BNC coaxial connectors can short out the sensor and cause an erroneous readings or transmitter failure. A pack of non-conductive electrical connection lubricant (ECL or “Dielectric Tune-up Grease”) has been included with the liquid level sensor packaging to reduce the possibility of this occurring.

To connect the coaxial cable to the BNC connector on the capacitance level sensor:

1. Apply a small amount of ECL to any of the BNC connectors that may be exposed to moisture.
2. Mate the ECL-coated connectors then remove any excess ECL from the outside of the connector.
3. Cover the ECL-coated connections with a short section of heat-shrink tubing, also included, for added moisture protection.

NOTE

MSDS sheets for the ECL are available upon request.

CONNECTING A LIQUID HELIUM LEVEL SENSOR

The instrument is connected to the liquid helium level sensor with a 4-conductor cable which has a 9-pin D-sub male connector on one end that mates with the connector used at the instrumentation feed through connector on the cryostat. This connector is typically a multi-pin circular type connector.

Prepare the sensor to be connected to the instrument by soldering the sensor leads to a male 9-pin D-Sub connector which will connect to the female 9-pin D-Sub connector on the transmitter. Refer to the *Appendix* of this manual and the AMI sensor manual for the proper pin out and wire color connections. Connect the sensor to the connector on the transmitter.

WARNING

Although the sensor connector terminals are isolated from earth ground and therefore touching one terminal is not hazardous, the voltage between terminals is at a hazardous potential. The sensor connector is for use with an AMI LHe sensor and the wiring for the sensor is to have no live parts which are accessible. Conductors connected to its terminals must be insulated from user contact by basic insulation rated for 150 V_{AC} (Category I).

The lead wire for the sensor may be sized by the following equation:

$$R = 420 - 5.21L$$

where R is the maximum allowable resistance (in ohms) for each lead wire from the instrument to the sensor, and L is the active length of the connected helium level sensor in inches. Tables for active sensor length vs. lead wire distance are provided below.

Minimum recommended wire gauge for copper lead wire

Distance	$R=367$	$R=315$	$R=263$	$R=211$	$R=107$	$R=3.2$
	$L=10''$	$L=20''$	$L=30''$	$L=40''$	$L=60''$	$L=80''$
10 ft.	36 AWG				36 AWG	34 AWG
20 ft.						30 AWG
30 ft.						28 AWG
40 ft.						27 AWG
50 ft.						24 AWG
100 ft.						22 AWG
200 ft.					32 AWG	16 AWG
500 ft.						

NOTE If the system is an Autofill system, proceed to section “Setting Up an Autofill System” on page 17. If the installed capacitance or liquid helium level sensor(s) are used for indication only (not autofill), proceed to “Energizing the Model 1700 Instrument” on page 23.

SETTING UP AN AUTOFILL SYSTEM

Autofill systems are useful in applications where liquid level in a dewar must be maintained without operator intervention.

To create an autofill system, a cryogenic liquid source must be attached to the target or level controlled dewar via a solenoid-controlled valve. The valve will be controlled by the Model 1700 Instrument.

AUTOFILL SYSTEM DESCRIPTION

For autofill, the system consists of a Model 1700 Instrument with a liquid level sensor, and a solenoid-operated flow valve. The instrument makes continuous level measurements and based on level, energizes the valve to begin liquid transfer. The transfer is stopped when the measured level reaches a user-determined point.

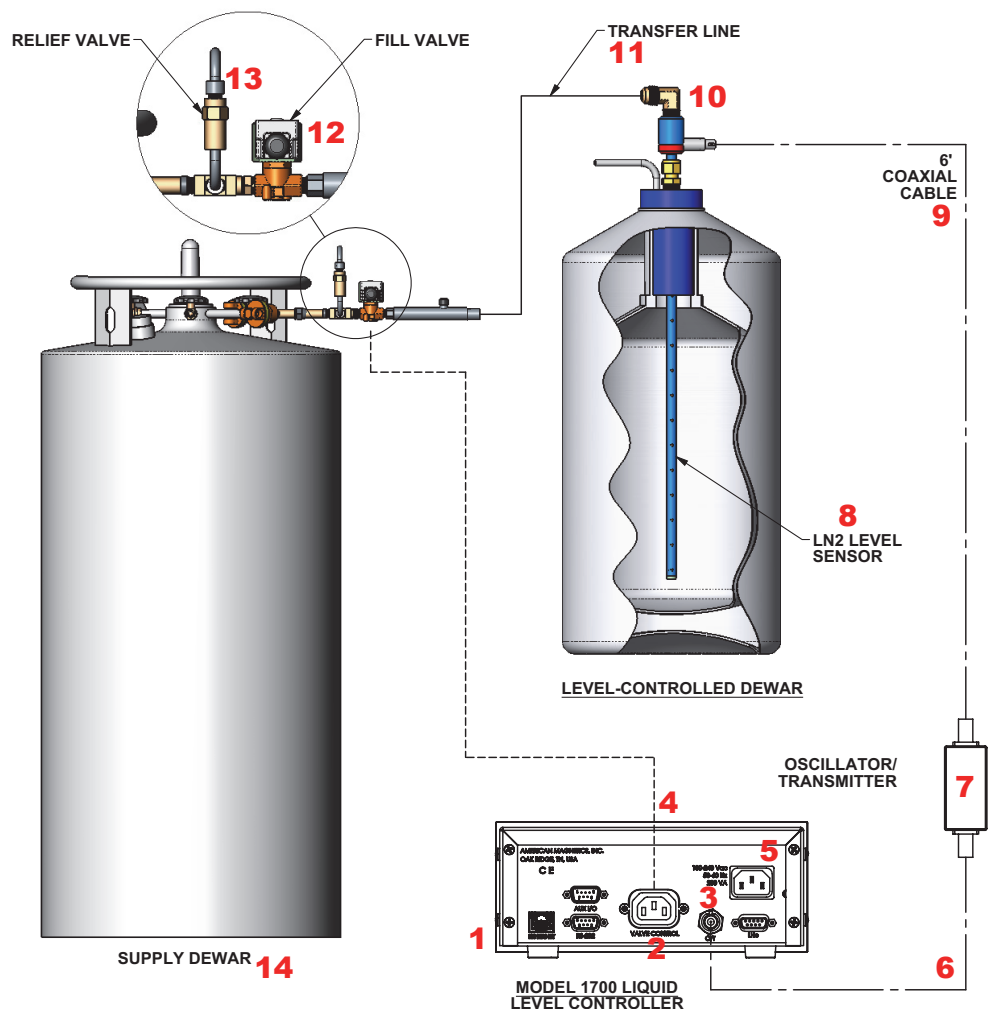

Typical Autofill Setup

Standard Autofill Setup Description

Number	Item
1	Model 1700 Liquid Level Instrument (Level Controller)
2	IEC60320 C13 socket labeled VALVE CONTROL
3	BNC connector labeled O/T
4	Solenoid-operated flow control valve line cord with IEC60320 C14 plug
5	Instrument IEC60329 C14 Power cord socket
6	Coaxial cable connecting the oscillator / transmitter and the instrument
7	Oscillator / Transmitter (optional; refer to the figure on page 14)
8	Level Sensor for level controlled or target dewar
9	Coaxial cable connecting the Oscillator / Transmitter and the liquid level sensor (optional; refer to the figure on page 14)
10	Fill port on target dewar
11	Transfer line attached to the target dewar and the fill solenoid valve on the source dewar
12	Solenoid-operated fill valve
13	Supply dewar relief valve
14	Supply dewar

AUTOFILL SYSTEM SETUP

CAUTION

A relief valve must be used in autofill systems to ensure no cryogenic liquid can be trapped in a transfer line volume where expansion can cause damaging pressure. This can occur if the solenoid operated fill valve and the supply dewar isolation valve are closed, trapping a cryogenic liquid in a confined volume. All AMI transfer line systems include a relief valve to preclude this sort of event.

1. Mount the level sensor (**8**) in the target dewar.
2. Connect the transfer line (**11**) and fill solenoid valve (**12**) or supply manifold to the source dewar.
3. Connect the other end of the transfer line to the fill port (**10**) on the valve/manifold of the target dewar.
4. Connect the sensor to the instrument.
 - a. For distances of 6 feet and less, connect the coaxial cable (**6**) between the BNC connector on the liquid level sensor and the BNC connector on the back of the instrument labeled **O/T** (**3**).

- b. For distances greater than 6 feet, connect the coaxial cable (9) between the BNC connector on the liquid level sensor and the BNC connector on the oscillator / transmitter (7). Use a second length of coaxial cable (6) to connect between the oscillator / transmitter (7) and the BNC connector on the back of the instrument labeled **O/T** (3).
5. Connect the solenoid valve (12) to the IEC60320 C13 valve socket¹ on the Model 1700 Instrument rear panel labeled **VALVE CONTROL** (2).

Connect the IEC320 C14 inlet connector and instrument power cord (5) to an appropriate power source (see below).

NOTE Should the nitrogen level sensor become disconnected from the instrument, a **LOSS OF SENSOR** message will be displayed (as shown at right) and the autofill valve will be shut (**M-CLOSED**). When the sensor connection has been restored, the instrument will display the level but the autofill state will have to be manually changed back to **AUTOFILL**.

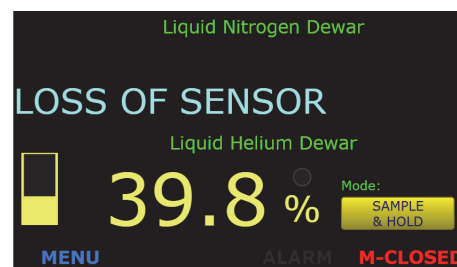

1. The valve socket must be IEC60320 C13 type.

POWER REQUIREMENTS

WARNING

The Model 1700 Instrument operates on 50-60 Hz power and may be powered from 100-240 VAC. Insure that the input ground terminal is connected securely to an external earth ground.

Ensure the detachable mains supply cord is of suitable rating, i.e. 10 A (min) at 125 VAC for North America.

Ensure the power switch is in the OFF (●) position. Plug the Model 1700 Instrument line cord into the power entry module on the instrument rear panel and into the appropriate power receptacle.

0-10 V_{DC} RECORDER OUTPUT

The Model 1700 instrument provides a 0-10 V_{DC} output on the AUX I/O connector (refer to “Aux I/O Pin Definitions” on page 100) corresponding to 0-100% of liquid level. This output can be assigned to either level measurement channel (refer to “Analog output signals” on page 42). Connect the voltage output on the AUX I/O connector to a suitable receiver being careful not to exceed the impedance restrictions (refer to “Model 1700 Specifications @ 25°C” on page 8).

4-20 mA CURRENT LOOP OUTPUT

The Model 1700 instrument provides a 4-20 mA_{DC} output on the AUX I/O connector (refer to “Aux I/O Pin Definitions” on page 100) corresponding to 0-100% of liquid level. This output can be assigned to either level measurement channel (refer to “Analog output signals” on page 42).

The instrument requires an external power supply for current loop operation. Connect a suitable power supply as shown below.

CAUTION

It is extremely important to observe all polarities and to not exceed +32VDC for the loop power supply in order to prevent damage to the 4-20mA driver circuit.

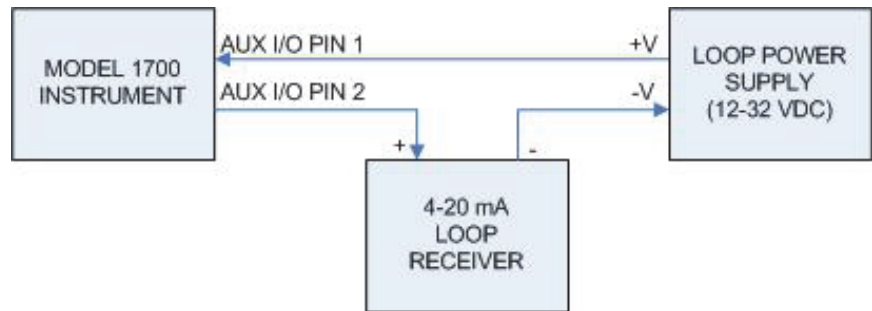

OPERATION

This section describes the operation of the Model 1700 Instrument.

ENERGIZING THE MODEL 1700 INSTRUMENT

1. Turn the power switch on the front panel of the instrument to the On (I) position. The display will briefly show the AMI logo and then boot information.
2. The boot process takes approximately 30 seconds, This time can be longer (approximately 2 minutes) if the instrument has been configured for a network connection and then is booted without the network present.

NOTE If the instrument was purchased with a level sensor, the instrument will be configured and calibrated at the factory.

3. When the boot process is complete, the instrument will display the home (level) screen.

- a. If the instrument is configured for only liquid nitrogen level, the display will look similar to the following:

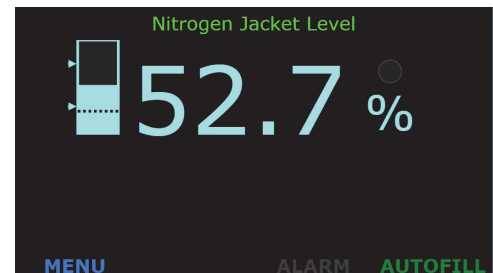

LN₂ Home Screen

- b. If the instrument is configured for only liquid helium level, the display will look similar to the following:

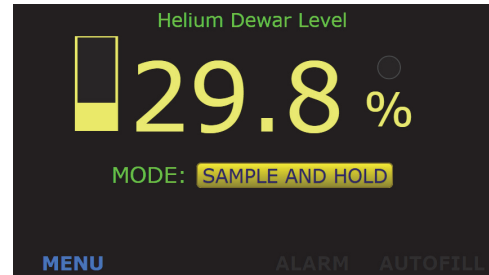

LHe Home Screen

- c. If the instrument is configured for both liquid nitrogen and liquid helium levels, the display will look similar to the following:

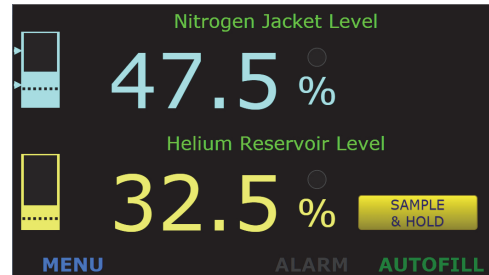

Both LN2 and LHe Home Screen

- d. If the instrument requires calibration¹, refer to the following chapter to calibrate the instrument with an AMI level sensor.

1. If the instrument was purchased with level sensor(s), the instrument will be shipped set up and calibrated.

SCREEN NAVIGATION

HOME SCREEN FOOTER

Every screen has a footer. The level home screen (refer to Figure as an example) displays both level information and buttons in the footer to navigate to other screens.

The home screen footer appears as shown at right:



Model 1700 Instrument Home Screen Footer

No.	Name	Function
①	MENU	Takes the user to the menu screen
②	ALARM	When illuminated, displays an alarm condition
③	AUTOFILL	Indicates the condition of the autofill function

NAVIGATING THE INSTRUMENT MENUS

The menu system is invoked by pressing the Menu button in the lower left corner of the instrument level display screen.



MENU button on HOME screen

When invoked, the MENU screen will be displayed:

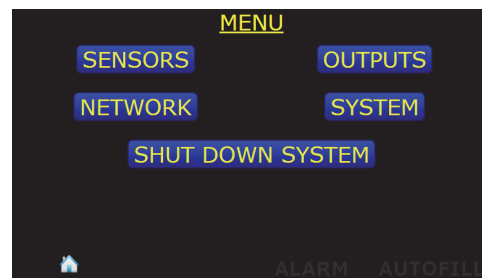

MENU Selection Screen

Pressing the Home icon in the lower left corner of the screen will display the Home screen.



HOME button on MENU screen

Once a MENU has been chosen, a back button will be presented to the right of the Home icon. This button will return the user to the previously displayed screen.



BACK button

MENU OVERVIEW

The Model 1700 Instrument displays menus on the graphic display to the left of the keypad. Press **MENU** on the menu keypad to display options on the graphic display. Menu options are listed in the table below.

NOTE The following table shows all menu choices, some of which will not be shown based on the instrument configuration.

Model 1700 Dual Level Instrument Menu Structure

Menu Label	Function	Field Type
SENSORS	NITROGEN OSCILLATOR:	Information: INTERNAL, EXTERNAL ^a
	N2 LEVEL ON HOME SCREEN?	Toggles between: YES, NO
	HELIUM SENSOR TYPE:	Toggles between: 2K, 4.2K
	He LEVEL ON HOME SCREEN?	Toggles between: YES, NO
	CALIBRATE NITROGEN	Transfer to another screen
	CALIBRATE HELIUM	Transfer to another screen

Model 1700 Dual Level Instrument Menu Structure

Menu Label	Function	Field Type
OUTPUTS	ALARM RELAY No.1 SOURCE:	Toggles between: DISABLED, NITROGEN, HELIUM
	(ALARM RELAY No. 1) SETPOINT:	Data entry <value> %
	(ALARM RELAY No. 1) ALARM WHEN LEVEL <state>	Toggles between: ≤, ≥ SETPOINT
	ALARM RELAY No.2 SOURCE:	Toggles between: DISABLED, NITROGEN, HELIUM
	(ALARM RELAY No. 2) SETPOINT:	Data entry <value> %
	(ALARM RELAY No. 2) ALARM WHEN LEVEL <state>	Toggles between: ≤, ≥ SETPOINT
	AUTOFILL SOURCE:	Toggles between: DISABLED, NITROGEN, HELIUM ^b
	AUTOFILL CONTROL: START:	Data entry <value> % ^b
	AUTOFILL CONTROL: STOP:	Data entry <value> % ^b
	FILL TIMEOUT (N2 ONLY):	Data entry <value> MINUTES ^b
	0-10 Vdc SOURCE:	Toggles between: DISABLED, NITROGEN, HELIUM ^b
	4-20 mA SOURCE:	Toggles between: DISABLED, NITROGEN, HELIUM ^b
NETWORK	ADDRESS: <value>	Data entry or Information
	NETMASK: <value>	Data entry or Information
	GATEWAY: <value>	Data entry or Information
	ADDRESSING:	Toggles between: DISABLED, STATIC, DYNAMIC
	MAC ADDRESS:	Information: <value>
SYSTEM (page 1)	NITROGEN SENSOR NAME:	Data entry: <value>
	HELIUM SENSOR NAME:	Data entry: <value>
	SYSTEM DATE & TIME:	Information: <values> ^a
	(SYSTEM DATE & TIME) SET	Transfer to another screen
	(SYSTEM SETTINGS) PAGE 2	Transfer to another screen

Model 1700 Dual Level Instrument Menu Structure

Menu Label	Function	Field Type
SYSTEM: DATE & TIME (page 4)	SYSTEM DATE AND TIME: YEAR	Data entry
	SYSTEM DATE AND TIME: MONTH	Data entry
	SYSTEM DATE AND TIME: DAY	Data entry
	SYSTEM DATE AND TIME: HOUR	Data entry
	SYSTEM DATE AND TIME: MIN	Data entry
SYSTEM (page 2)	SERIAL NUMBER:	Information: <value> ^a
	HARDWARE VERSION:	Information: <value> ^a
	DATE OF MANUFACTURE:	Information: <value> ^a
	FIRMWARE VERSION:	Information: <value> ^a
	HELIUM POWER SUPPLY:	Information: NONE
	RESET INSTRUMENT TO FACTORY DEFAULTS	Transfer to another screen
SYSTEM (page 3)	RESET INSTRUMENT	Performs a function
CALIBRATE TOUCH SCREEN	Assists user in performing the instrument touch screen calibration	Transfer to another screen
SHUT DOWN SYSTEM	Shuts down the instrument in an orderly fashion which reduces boot time for the next power on.	Transfer to another screen
SENSORS: CALIBRATE NITROGEN	OSCILLATOR PERIOD:	Information: <value> ^a μs
	SENSOR ACTIVE LENGTH:	Data entry: <value> cm
	PERFORM MAX CAL	Transfer to another screen and Information: <value> ^a μs
	PERFORM MIN CAL	Transfer to another screen and Information: <value> ^a μs
	NO SENSOR CAL	Transfer to another screen and Information: <value> ^a μs
	APPROX CAL. VALUE:	Data entry: <value>
	(APPROX CAL. VALUE:) APPLY	Performs a function

Model 1700 Dual Level Instrument Menu Structure

Menu Label	Function	Field Type
SENSORS: CALIBRATE HELIUM ^b	SENSOR SAMPLE INTERVAL:	Data entry: <value> min
	MEASURE SENSOR VOLTAGE	Performs a function: <value> V ^a
	SENSOR ACTIVE LENGTH:	Data entry: <value> cm
	CONTIN. MEASURE TIME LIMIT:	Data entry: <value> min
	DIRTY SENSOR MODE:	Toggles between: DISABLED, ENABLED

- a. Displays the state or value (display only).
- b. OUTPUTS Menu page 2

EDITING A FIELD

Once a field on a screen has been selected for editing, the footer changes to appear as follows:



Model 1700 Instrument Footer during editing a field

Button No.	Name	Function	Reference Paragraph
①	SAVE	Saves the entries made on the screen. The footer changes to the footer shown in Table , above.	
②	CANCEL	Exits out of the screen, not saving entries. The footer changes to the footer shown in Table , above.	
③	ALARM Status	Refer to Table , above.	
④	AUTOFILL Status		

MENU NAVIGATION

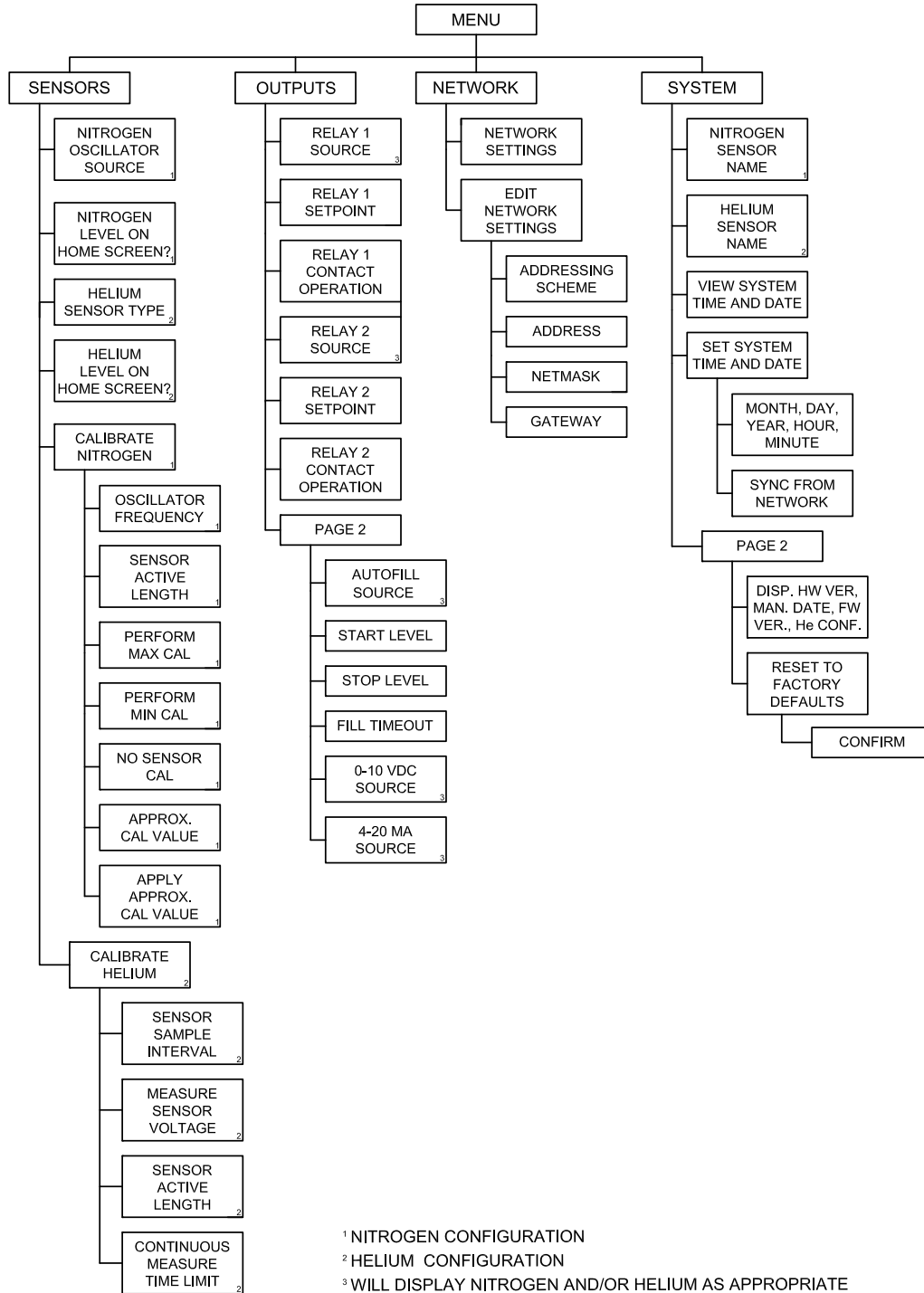

Model 1700 Menu Structure

CAPACITANCE (LIQUID NITROGEN) LEVEL

CONFIGURE THE INSTRUMENT TO DISPLAY NITROGEN LEVEL

NOTE If the instrument was purchased with a capacitance-based level sensor, Steps 1 through 5, below have already been performed.

1. From the main screen, choose the following: MENU > SENSORS.
2. The instrument has a built-in sensor oscillator which will be used if the level sensor is connected to the BNC connector on the rear panel of the instrument with a maximum of 6 foot of RG59/U coaxial cable (refer to the figure on page 2). Ensure the "NITROGEN OSCILLATOR:" field displays "INTERNAL".

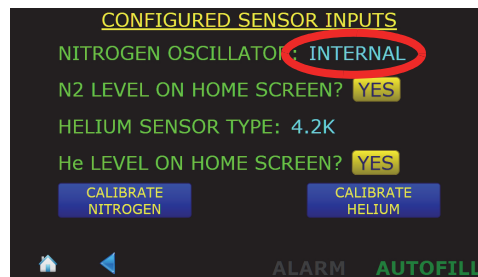

INTERNAL Oscillator Indicated

3. If the sensor is greater than 15 feet from the instrument, an external oscillator/transmitter will have to be used and the "NITROGEN OSCILLATOR:" will display "EXTERNAL" (refer to the figure on page 3).
4. Ensure that N2 LEVEL ON HOME SCREEN? is set to YES.
5. Press the Home icon at the bottom of the screen.

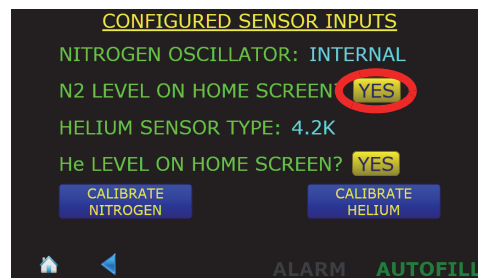

Nitrogen Level Displayed on Home Screen

SUPERCONDUCTING (LIQUID HELIUM) LEVEL

CONFIGURE THE INSTRUMENT TO DISPLAY HELIUM LEVEL

NOTE If the instrument was purchased with an AMI LHe level sensor, Steps 1 through 4, below have already been performed.

1. From the main screen, choose the following: MENU > SENSORS.

- 2. The instrument will display the instrument configuration vis-à-vis the LHe level sensor, 4.2K or 2K. Note that this configuration is set at time of manufacture and is not alterable by the user.

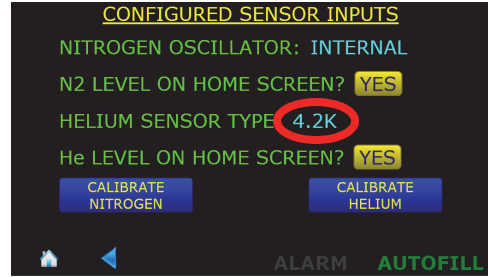

Type of LHe Level Sensor

- 3. Ensure that He LEVEL ON HOME SCREEN? is set to YES.

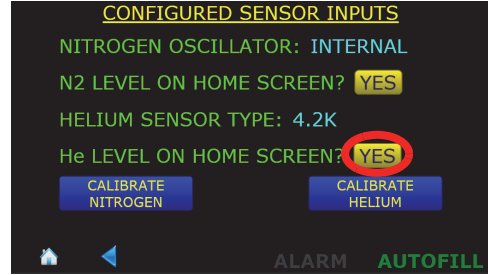

Helium Level On Home Screen

- 4. Press the **CALIBRATE HELIUM** button.

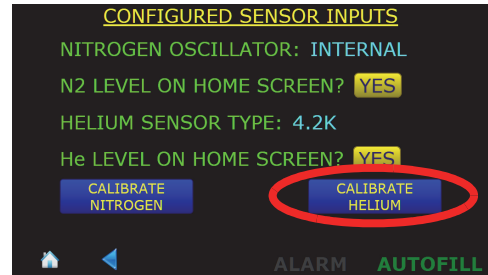

Helium Level On Home Screen

- 5. Press the **SENSOR ACTIVE LENGTH** field.

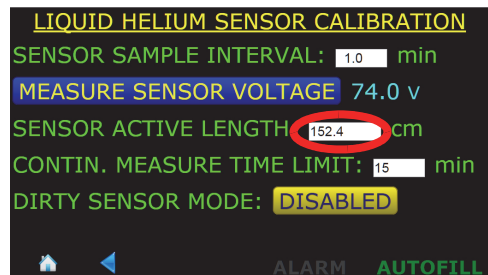

Calibrate Helium Screen

- In the numeric pop-up keypad, enter the sensor active length in centimeters. Press Enter when finished.

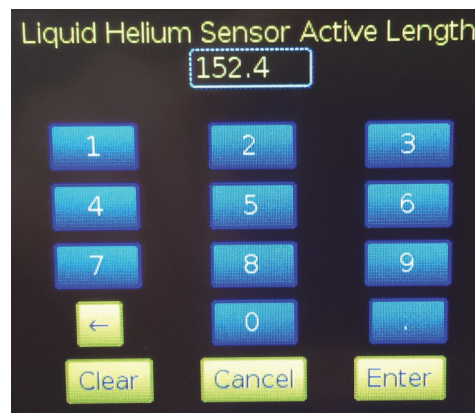

Numeric Keypad

- Press in the **CONTIN. MEASURE TIME LIMIT** field.
- Using the pop-up numeric keypad, enter the maximum amount of time that the sensor should remain energized in the **MEASURE CONTINUOUSLY** mode before automatically changing to the **SAMPLE AND HOLD** mode. This limit prevents inadvertent sensor energization for long periods of time which will cause excessive liquid helium boil off. When the sensor is energized (**MEASURE CONTINUOUSLY**) a timer is started and after the **CONTIN. MEASURE TIME LIMIT** is reached, the sensor is de-energized (switches back to **SAMPLE AND HOLD** mode).

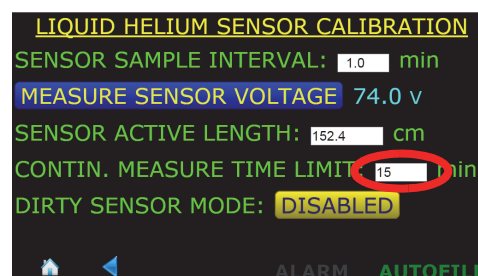

Calibrate Helium Screen

NOTE Setting the **CONTINUOUS MEASURE TIME LIMIT** to 0 (zero) disables the function.

- Set the **SENSOR SAMPLE INTERVAL** to an appropriate value. This value is used by the **SAMPLE AND HOLD** timer to determine how often the reading is updated. The timer is started when the instrument is powered up or when this value is changed.

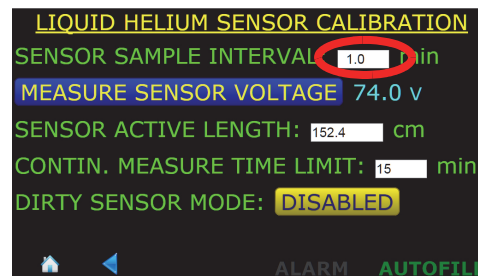

Setting the Sample Interval

NOTE Setting the **SAMPLE INTERVAL** to 0 (zero) disables the **SAMPLE AND HOLD** function.

- Press the Home icon in the screen footer.

SENSOR BURNOUT PROTECTION

Operating the sensor in a vacuum without contact with liquid helium can cause thermal damage and/or destruction of the superconducting filament. The Model 1700 is equipped with circuitry that automatically prevents this type of damage from occurring, if the instrument's LENGTH setting is properly set to the active length of the connected sensor. If excessive sensor resistance is detected, the Model 1700 display will indicate burnout protection is in effect and the sensor current will be turned off for a minimum of six seconds after which time the instrument will attempt to resume normal operation. When the sensor resistance has returned to approximately the expected value, normal operation will be restored. No relay or alarm states are affected.

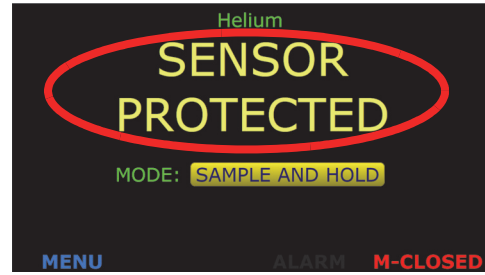

Helium Level Sensor Protection Mode

If an attached sensor is not actually installed in a cooled cryostat, then the sensor burnout protection will activate as soon as the Model 1700 is energized and a liquid helium level reading is attempted. This should be considered normal until the sensor is cooled in the helium environment.

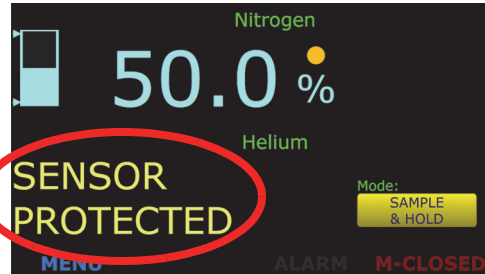

Helium Level Sensor Protection Mode

SAMPLE AND HOLD OPERATION

While viewing the home screen, toggle between **SAMPLE AND HOLD** and **MEASURE CONTINUALLY** modes by pressing the button.

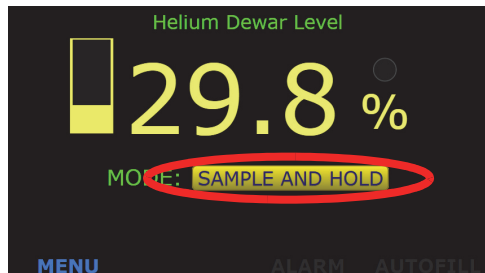

Helium Level Measurement Mode

OTHER LIQUID HELIUM FUNCTIONS

The instrument displays the LHe level sensor voltage. If the voltage is shown in light blue, it is the actual (real-time) voltage as the instrument is in **MEASURE CONTINUALLY** mode. If it is displayed in gray, it is the voltage measured the last time the sensor was energized (**SAMPLE AND HOLD** mode). To update the reading, press the **MEASURE SENSOR VOLTAGE** button and the level reading will be updated as will the displayed sensor voltage.

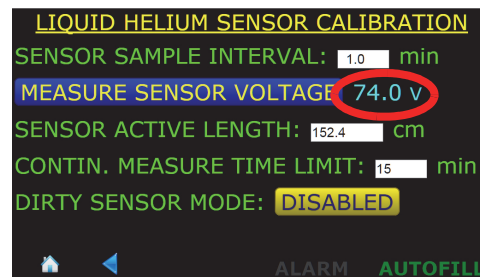

Helium Sensor Voltage

AMI expects the helium level sensor to be reasonably clean and free from oil, water, ice, etc. for proper operation. However, it is recognized that some experiments might result in some material being deposited on the sensor wire. Ice formation at some point on the sensor is a typical occurrence. Therefore, the Model 1700 has the capability of increasing the current for a short period of time at the beginning of the measurement cycle (in the **SAMPLE** mode only) to try and drive the resistive zone of the sensor wire past the dirty region. This operation may or may not be successful depending on the degree of sensor contamination. This mode should be viewed as a stopgap measure only. If correct readings cannot be reestablished, the only choice is to warm the sensor or remove for cleaning or replacement.

NOTE Operation in the dirty sensor mode increases liquid helium losses. Consequently, operation in this mode should not be used unless the sensor is known or anticipated to become dirty or the helium level measurement is in question due to unclean operation.

To enable the **DIRTY SENSOR MODE**, Press the **DISABLED** button until **ENABLED** appears and press **SAVE**.

Press the home icon in the footer to return to the home screen.

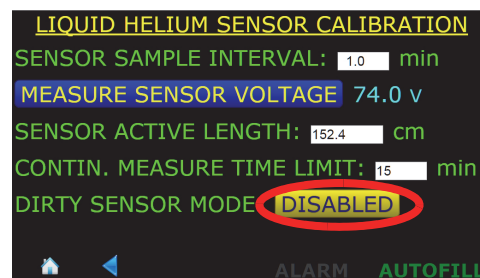

Dirty Sensor Mode

ALARMS AND RELAYS

The Model 1700 Instrument has two types of alarms, level-based and time-based alarms.

LEVEL-BASED ALARMS

The Model 1700 Instrument has two user-configurable level alarms. Each alarm can be triggered by either level measurement (for dual level configured instruments). Each alarm can be configured to be active above or below a user-defined setpoint.

When an alarm condition occurs, an audible alert will sound and visual indication on the front panel.

Alarm №1 and №2 have relays associated with them. These relays have Normally Open (NO) contacts. The alarm/relays can be assigned to either the helium or nitrogen channel and the alarm/relay can each be configured to have the alarm active when the reading is either \leq or \geq the setpoint. As an example of this setup flexibility, a level channel can be configured to have an alarm condition when the level is outside a normal operating band, or in a dual level configuration, each channel can have a low level alarm.

TIME-BASED FILL ALARM (NITROGEN ONLY)

The Model 1700 Instrument has an alarm to indicate that there is a problem with the LN₂ autofill function. If enabled, the instrument will start a timer when an autofill condition is initiated, and if the level has not reached the fill stop level within the user-set period of time, an Autofill Timeout alarm will occur.

This alarm will cause three things to occur:

1. the de-energizing of the fill valve socket on the instrument rear panel,
2. an audible alarm will sound,
3. a visual indication in the footer of the instrument front panel which shows repeatedly **ALARM > NITROGEN > TIMEOUT > MUTE?**¹ > **ALARM >** etc.
4. The blue AUTOFILL text in the right side of the screen footer will turn to red T-CLOSED indicating that the fill timeout has automatically closed the fill valve by deenergizing the power socket on the instrument rear panel.

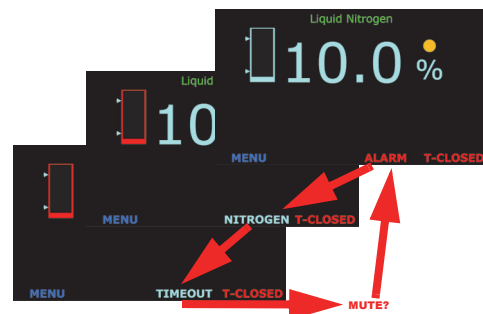

Fill Timeout Alarm Screen

This Autofill Timeout function can be disabled by setting the interval to 0 minutes.

MULTIPLE ALARMS

More than one alarm condition can occur at the same time. The footer will display the cause(s) of the alarm condition(s).

CONFIGURING ALARM SETPOINTS

1. From the MENU choice, select OUTPUTS and the first page of the Output Configuration screen will be displayed.

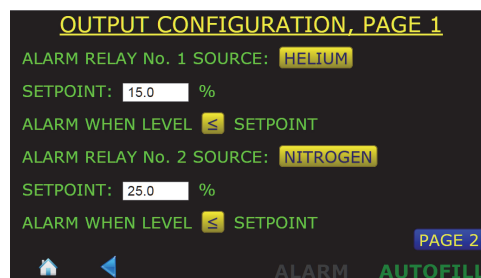

Output Configuration Screen, Page 1

2. If the instrument is configured to display both nitrogen and helium, toggle the Alarm Relay Source fields to choose the appropriate level source. If the instrument is configured for either nitrogen or helium, the source will automatically be assigned to the configured level.

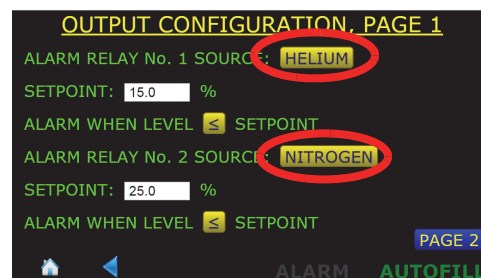

Relay Source Configuration

3. Set the levels at which the alarm will be triggered in the Setpoint fields.

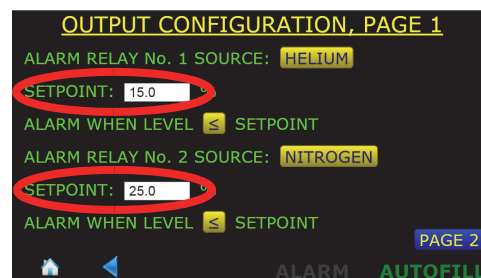

Relay Setpoints

1. The **MUTE?** function is not applicable to the screen on a remote browser since audible alarms are not supported remotely

4. Use the \leq or \geq button to toggle between the two states of alarm, either alarm when the indicated level is less than or equal to the setpoint or alarm when the indicated level is greater than or equal to the alarm setpoint.

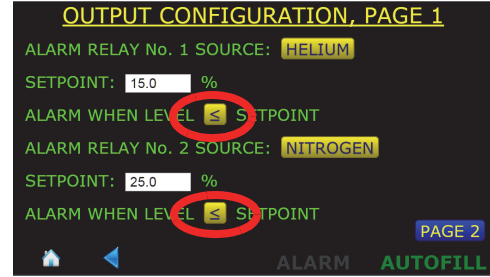

Alarm Condition Above or Below Setpoints

ACKNOWLEDGING AN ALARM

NOTE The alarms are not “latched” so if the alarm condition clears itself, the instrument will remove the alarm condition.

1. When an alarm is initiated, several things will occur:

- a. The bar-graph level display that is causing the alarm condition as well as the sensor name will flash red.
- b. The ALARM button in the footer will indicate what the alarm condition is, either by showing LO LEVEL, HI LEVEL, or TIMEOUT.

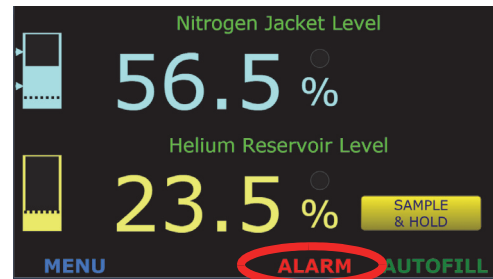

Alarm Annunciator

- c. An audible alarm will be energized.

2. For example, a helium low level alarm will flash the following three displays in a repeating fashion:

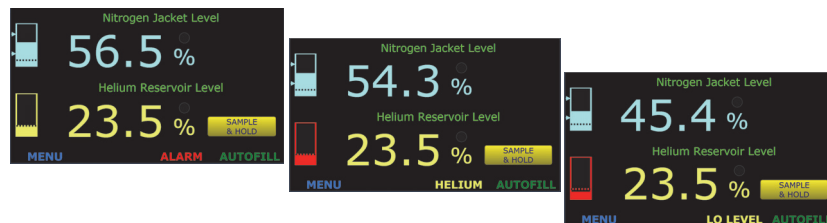

LO LEVEL Alarm Condition Footer Displays

MUTING AN ALARM

The audible alarm can be muted by pressing the **ALARM** button in the footer. As long as the alarm condition occurs with muting enabled, the **ALARM** button in the footer will alternate between the alarm conditions (Figure) and **MUTED**.

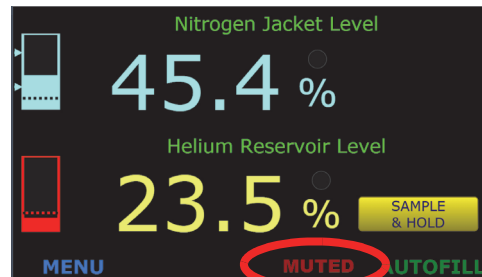

Muted Alarm Condition

RESETTING THE AUTOFILL TIMEOUT ALARM

1. Press the red **T-CLOSED** text in the right side of the footer twice until **M-CLOSED** is displayed.
2. Press **SAVE**.
3. To restart the autofill process, Press the **M-CLOSED** annunciator once and the **AUTOFILL** annunciator will be displayed. Press **SAVE** and the autofill sequence will be enabled.

CONFIGURE THE AUTOFILL FUNCTION

There are several variables that must be addressed to set up an autofill system. These include the level indication that will be used to control autofill, the Fill Start level (A), the Fill Stop Level (B), and the fill timeout interval.

SETTING THE AUTOFILL PARAMETERS

1. From the Menu screen, choose **OUTPUTS** and then choose **PAGE 2**.
2. Toggle the **AUTOFILL CONTROL** button until **NITROGEN** is displayed.

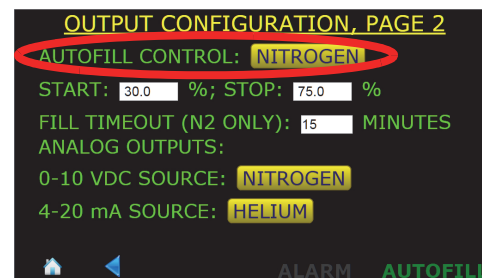

Autofill Level Control Selection

3. Enter the Fill **START** and **STOP** levels.

NOTE If the **START** value is set to **0.0%** the autofill function will be disabled.

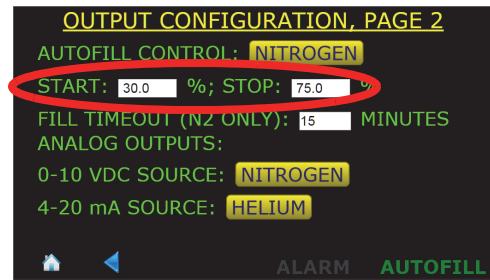

Autofill Level Start Setting

4. Enter the **FILL TIMEOUT (N2 ONLY)** interval. Refer to on page 36 for a description of the Autofill timeout function.
5. Press the home icon in the footer to return back to the level display.

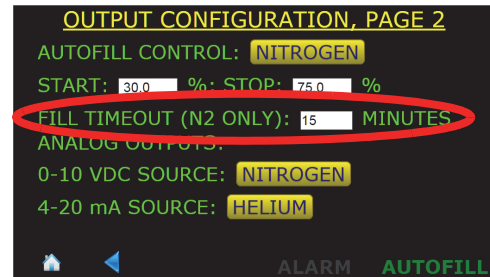

Autofill Timeout Setting

ENABLE THE AUTOFILL FUNCTION

The autofill function must be enabled from the front panel of the instrument. After the autofill control loop has been configured (steps in section) the instrument will be left in the valve manually-closed state.

To enable the autofill function:

1. Press on the **M-CLOSED** icon in the display footer until it reads **AUTO-FILL**.
2. Press **SAVE** to enable the autofill function.
3. The AUTOFILL button has three states:

Autofill Settings

Function	Operation	Overrides
AUTOFILL	Maintains level between fill START and STOP setpoints.	Autofill will alarm and cease if fill valve stays open for ≥ the FILL TIMEOUT setting (nitrogen AUTOFILL CONTROL only).
M-OPEN^a	Energizes the valve control socket on the rear panel.	None
M-CLOSED^b	De-energizes the valve control socket on the rear panel.	None

a. Manual Open

b. Manual Closed

SELECT THE APPROPRIATE UNITS ON THE DISPLAY

Touch the units on the display to change the units. The available units are percent (%), inches (in), and centimeters (cm).

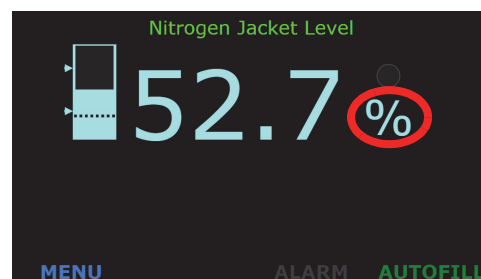

LN₂ Home Screen

ANALOG OUTPUT SIGNALS

Refer to “Aux I/O Connector” on page 100 of the Appendix for a connector pin-out.

CONFIGURING THE ANALOG OUTPUTS

1. From the **MENU** screen, choose **OUTPUTS**, then **Page 2**.
2. If necessary, choose the source for the **0-10 VDC** output and **4-20 mA** output.
3. Press the **SAVE** button to save the choice (or **CANCEL** to quit without making a change).
4. Press the home icon to go back to the home screen.

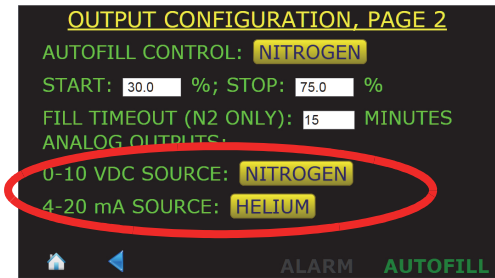

Analog Outputs Source Selection

ETHERNET CONNECTIVITY

IP ADDRESSING SCHEME

1. From the **MENU** screen, choose **NETWORK**. The current settings will be displayed.

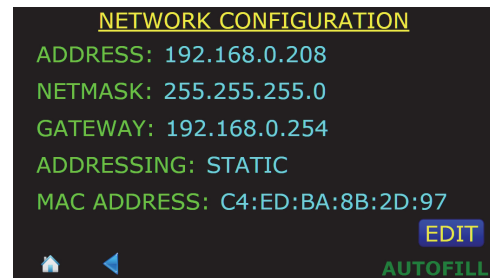

Network Selection

2. To change the settings, choose **EDIT**.

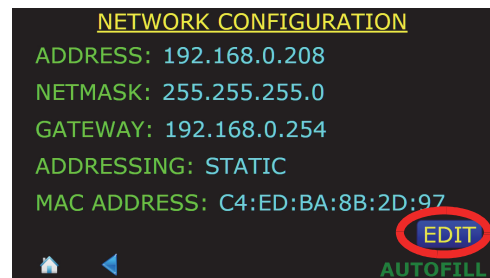

Editing Network Selection

3. In the **ADDRESSING**: button, choose **STATIC**, **DYNAMIC**, or **DISABLED** as appropriate.
4. If **STATIC** is chosen for the addressing scheme, enter **IP ADDRESS**, **NETMASK**, and **GATEWAY** addresses that are appropriate for the connected network. Once an address field is touched, the pop-up keyboard will be presented for data entry. Press **SAVE** when done.

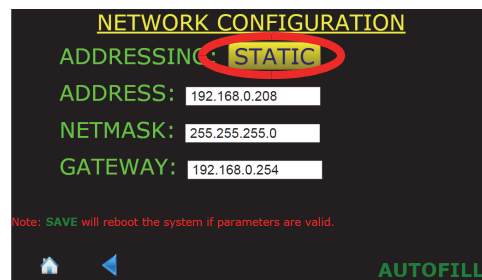

Editing Network Settings

5. If the **DYNAMIC** addressing scheme is chosen, the **IP ADDRESS**, **NETMASK**, and **GATEWAY** addresses will automatically be assigned from a network DHCP server. Press **SAVE** when done.
6. If changes are made, select the **SAVE** button and then the instrument will reboot and reconfigure itself with the chosen settings.

NOTE IP Addressing changes are not applied until the instrument is rebooted.

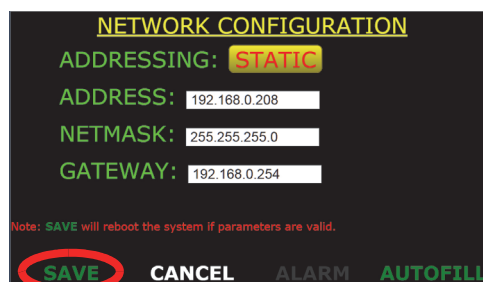

Saving Network Settings

ABNORMAL OPERATION

CAPACITANCE SENSOR CONTAMINATION

To ensure proper instrument calibration and operation, care must be taken to ensure the sensor is kept free of contaminants and not subjected to any force which would physically distort the sensor. Water or other electrically conducting substances in the sensor will disturb the measured capacitance and the instrument's response. Physically distorting the sensor in any way will also cause abnormal instrument operation by introducing variations in the sensor capacitance not due to liquid level. The absolute calibration of the instrument can be inaccurate if care is not taken to ensure the sensor is in the proper environment.

Cold sensors exposed to humidified air can show erroneous high level readings because the air contains moisture that can condense between the cold sensing tubes. A minute film of water can cause a shorted or

partially shorted condition, which results in false level readings. As the sensor warms, the moisture may evaporate and the sensor will again read correctly. This is a physical phenomenon and does not indicate any problem with your AMI level equipment. Limit or eliminate exposure of cold sensors to humidified air to avoid this condition.

If a sensor should require cleaning and the sensor is for use with liquids other than liquid oxygen, flushing with pure alcohol is recommended. The sensor cannot be used again until all the alcohol has been evaporated. Under no circumstances should the sensor be disassembled.

For sensors to be used with liquid oxygen (LOX), although measures are taken to minimize oils and greases during manufacture, no special cleaning required for LOX service is provided by AMI. Certified LOX cleaning is the responsibility of the customer.

DIRTY HELIUM SENSOR OPERATIONAL MODE

Refer to “Other Liquid Helium Functions” on page 35.

RESETTING THE INSTRUMENT TO FACTORY DEFAULTS

1. Press **MENU**, then **SYSTEM**, then **PAGE 2**.
2. Press **RESET INSTRUMENT TO FACTORY DEFAULTS**.

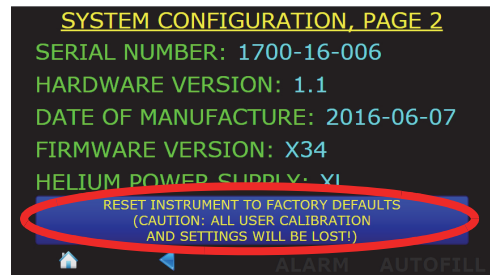

System Menu, Page 2

3. Press **RESET** and the instrument will be reset to factory defaults.

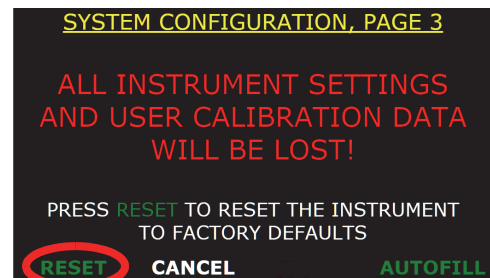

Resetting Instrument to Factory Defaults

SHUTTING THE INSTRUMENT DOWN

NOTE The Model 1700 Instrument is a Linux-based computer system and in order to ensure the file system is properly unmounted, the **SHUT DOWN SYSTEM** function should be invoked. If it is not, i.e. the instrument is shut down by removing power via the front panel power switch, the next time the instrument boots up, it will have to scan the memory system to ensure everything is in order.

1. The instrument should be shut down by using the menu function **SHUT DOWN SYSTEM**.

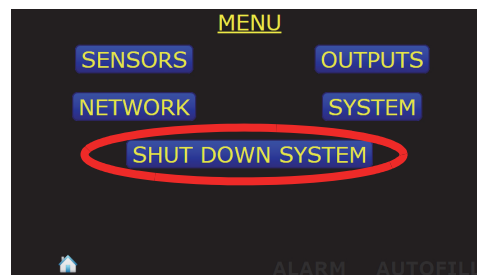

Invoking Instrument Shut Down

2. Choose **YES** to confirm shut-down.
3. When prompted, turn off the front panel power switch.

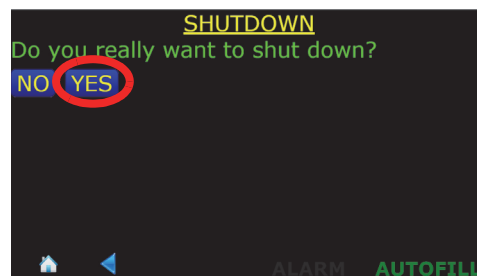

Confirming Instrument Shut Down

CALIBRATION

Model 1700 instrument is calibrated at the factory for a specific length sensor(s) for use in a specific liquid(s). The calibration length(s) and calibration liquid(s) are listed on the calibration sticker on the bottom of the instrument. For capacitance sensors, if the factory calibration method utilized was approximate, the calibration length will be noted as an approximate value.

SETTING THE SYSTEM DATE AND TIME

1. From the home screen, choose **MENU**.

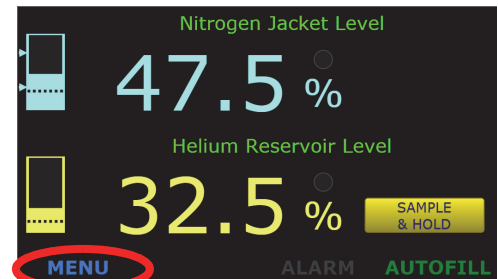

Menu Selection From Home Screen

2. From the **MENU** screen, choose **SYSTEM**.

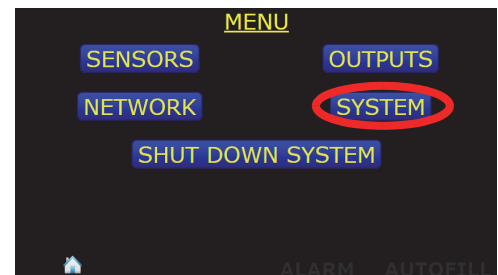

Menu Selection Screen

- From the **SYSTEM CONFIGURATION, PAGE 1** screen, choose **SET**.

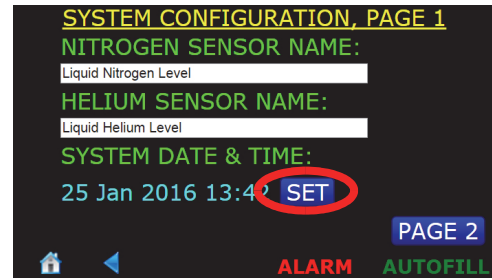

System Menu, Page 1

- Edit the **YEAR, MONTH, DAY, HOUR, and MIN** fields as necessary. Touching in a field will launch the keyboard on the screen. Edit the information in the field as necessary and choose **Enter** to enter the data in the field and close the pop up keyboard.

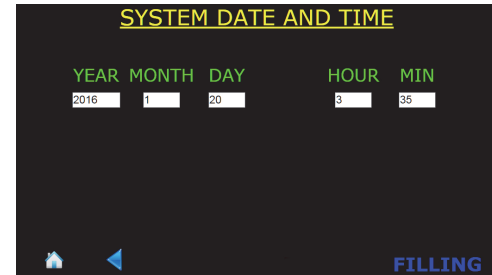

System Menu, Page 2

NOTE The clock is set to GMT at the factory and is battery backed. There is no provision in the instrument for automatic Daylight Savings Time correction.

- Choose **SAVE** in the footer after all the fields have been edited as necessary.

CAPACITANCE-BASED LEVEL CALIBRATION

UNDERSTANDING THE SENSOR ACTIVE LENGTH

American Magnetics, Inc. fabricates the liquid level sensor with two vent holes; a lower vent hole in the side wall near the bottom which is typically the minimum liquid level calibration point and the upper vent hole in the sensor side typically near the top of the sensor. The liquid level location approximately 2.5 cm (1 in) below the upper vent hole is typically the 100% calibration point.

The Model 1700 Instrument requires the user to enter the calibrated, or active length, (physical distance between the Min and Max calibration locations on the sensor) in order for the absolute units function (inches, cm) to be displayed if desired.

NOTE Without an active length entered, the instrument will not be able to read out in units other than percent.

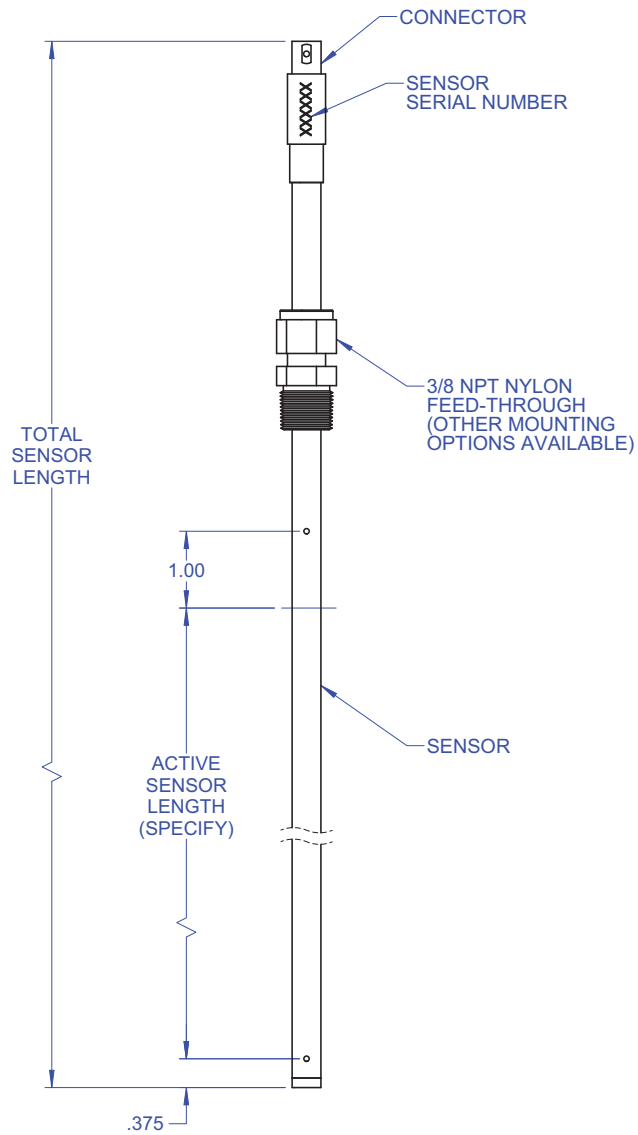

Typical Capacitance-based Liquid Level Sensor

The user must enter the sensor length in centimeters. Use the Active Length value noted on the level sensor documentation or measure the distance between the lower vent hole on the sensor and 1.0 inch (2.5 cm) below the upper vent hole on the sensor.

RELATIONSHIP BETWEEN CALIBRATION AND SENSOR LENGTH

The capacitance-based method of measuring the liquid level operates by measuring the frequency of an oscillator, which is contained in the oscillator/transmitter unit. As the liquid level varies, the value of the capacitance varies proportionally. Since the dielectric properties of liquids vary and the component tolerances for the sensor and oscillator introduce variations, a calibration is required to assure maximum accuracy for a specific sensor immersed in the target liquid. The calibration minimum and maximum settings correspond to the maximum and minimum oscillation frequencies, respectively, for a given sensor and target liquid configuration.

The length setting of the instrument is only provided as a means of scaling the 0% (minimum calibration) to 100% (maximum calibration) range of the measurement to meaningful units of length. During the calibration it is important to accurately measure the distance between the physical locations on the sensor corresponding to the maximum and minimum calibration points. The measured value for the length will be used in configuring the instrument for operation.

VARIATIONS IN THE DIELECTRIC WITH CHANGING DENSITY

For cryogenic liquids, the dielectric of the liquid will change with a change in density. The amount of change is dependent on the properties of the specific liquid. Figure illustrates the variations in dielectric for nitrogen vs. pressure under *saturated* conditions.¹ Since the instrument uses a capacitance-based method for determining liquid level, such a change in the dielectric of the liquid will result in a shift in the level reading of the instrument. The calibration procedures described herein are most accurate when applied in situations where the operating conditions of the cryo-vessel are relatively constant, i.e. the operating pressure and temperature of the cryo-vessel are relatively constant.

To minimize the effects of shifts in the dielectric of the target liquid, perform a closed dewar calibration (see page 59) at the expected operating condition of the cryo-vessel. If this is not feasible, then calibrate the sensor at atmospheric pressure and use the approximate calibration method to compensate for the shift of the dielectric when the cryogenic liquid is under pressure. For this type of approximate calibration, the *reference liquid* will be the *target liquid* at atmospheric pressure — see page 64 for a detailed discussion of the approximate calibration method. If any questions exist in regard to calibration issues, contact AMI for assistance in determining the optimal calibration strategy.

NOTE All references to “dielectric constant” herein refer to the unitless relative dielectric to ϵ_0 (ϵ_0 is the dielectric constant of a vacuum).

1. Data obtained from NIST Standard Reference Database 12.

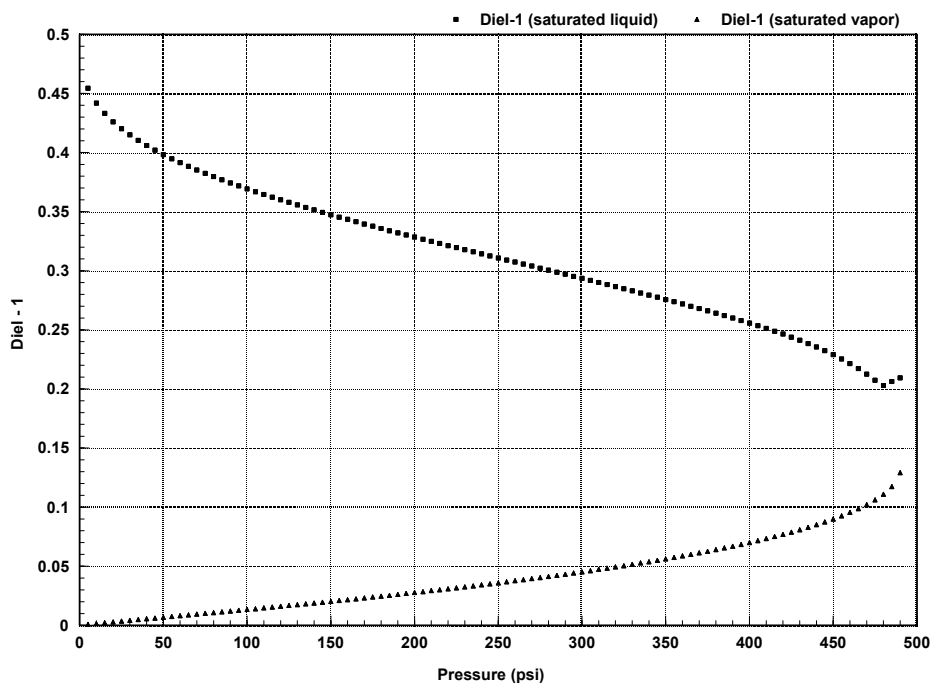

Dielectric vs. pressure for nitrogen under saturated conditions.

CAPACITANCE-BASED SENSOR CALIBRATION METHODS

The most straightforward calibration method is the *Open Dewar Calibration* which requires the customer to have access to a filled dewar where the full active length of the sensor can be dipped. The *Closed Dewar Calibration* method can be performed in situations where it is not feasible for the customer to dip the sensor into an open dewar, such as situations where the target liquid is under pressure. The closed dewar calibration is more complex and may require initial preparations to insure success.

Occasionally customers ask AMI to calibrate an instrument and sensor for a liquid which is not available at AMI for calibration purposes and/or for a sensor which is too long to be calibrated at our facilities.

For the case of the target liquid being unavailable, AMI uses liquid nitrogen as the reference liquid and an *Approximate Calibration* is performed using mathematical manipulation of the ratio of the dielectric constants between liquid nitrogen and the desired liquid. This procedure is outlined in the *Approximate Calibration* section beginning on page 64. The technique is intended to provide the instrument with an approximate calibration so that it can be used immediately by the customer. However, the customer is still expected to perform a more accurate calibration where feasible, such as the open dewar or closed dewar calibration, with the target liquid.

For the case where a sensor is too long to be calibrated in AMI facilities, AMI will perform a partial length open dewar calibration in liquid nitrogen, and then calculate the MAX calibration point. A dielectric ratio may also be subsequently utilized to adjust for a target liquid other than liquid nitrogen. The customer is expected to perform a more accurate open dewar or closed dewar calibration if feasible.

As a quick guide for selection of the best calibration method available, a calibration selection diagram is presented below. If the instrument and sensor are purchased as a unit from AMI, then the factory calibration will be adequate in most cases. However, for the exceptions noted in the previous paragraphs (which are *approximate* calibrations), the customer should perform a more accurate open dewar or closed dewar calibration. A customer performed calibration is also required for sensors that are purchased as a separate item from the instrument, since the instrument and sensor were not both available for calibration at AMI facilities.

Each Model 1700 Instrument must be calibrated with a sensor before use. If the instrument was purchased with a sensor to be used in liquid nitrogen, the instrument has been calibrated at the factory.

SELECTION OF CAPACITANCE SENSOR CALIBRATION METHODS

As a quick guide for selection of the best calibration method available, a calibration selection diagram is presented in . If the instrument and sensor are purchased as a unit from AMI, then the factory calibration, including sensor serial number and sensor physical parameter information entered at the factory, will be adequate in most cases. However, for the exceptions noted in the following paragraphs (which are *approximate* calibrations), the customer should perform a more accurate open dewar or closed dewar calibration if at all possible. A customer-performed calibration is also required for sensors that are purchased as a separate item from the instrument, since the instrument and sensor were not both available for calibration at AMI facilities.

The most straightforward calibration method is the *Open Dewar Calibration* which requires the customer to have access to a filled dewar where the full active length of the sensor can be dipped. The *Closed Dewar Calibration* method can be performed in situations where it is not feasible for the customer to dip the sensor into an open dewar, such as situations where the target liquid is under pressure. The closed dewar calibration is more complex and requires initial preparations to insure success.

Occasionally customers ask AMI to calibrate an instrument and Sensor Transmitter for a liquid which is not available at AMI for calibration purposes and/or for a sensor which is too long to be calibrated at our facilities. For the case of the target liquid being unavailable, AMI uses liquid nitrogen as the reference liquid and an *Approximate Calibration* is performed using mathematical manipulation of the ratio of the dielectric

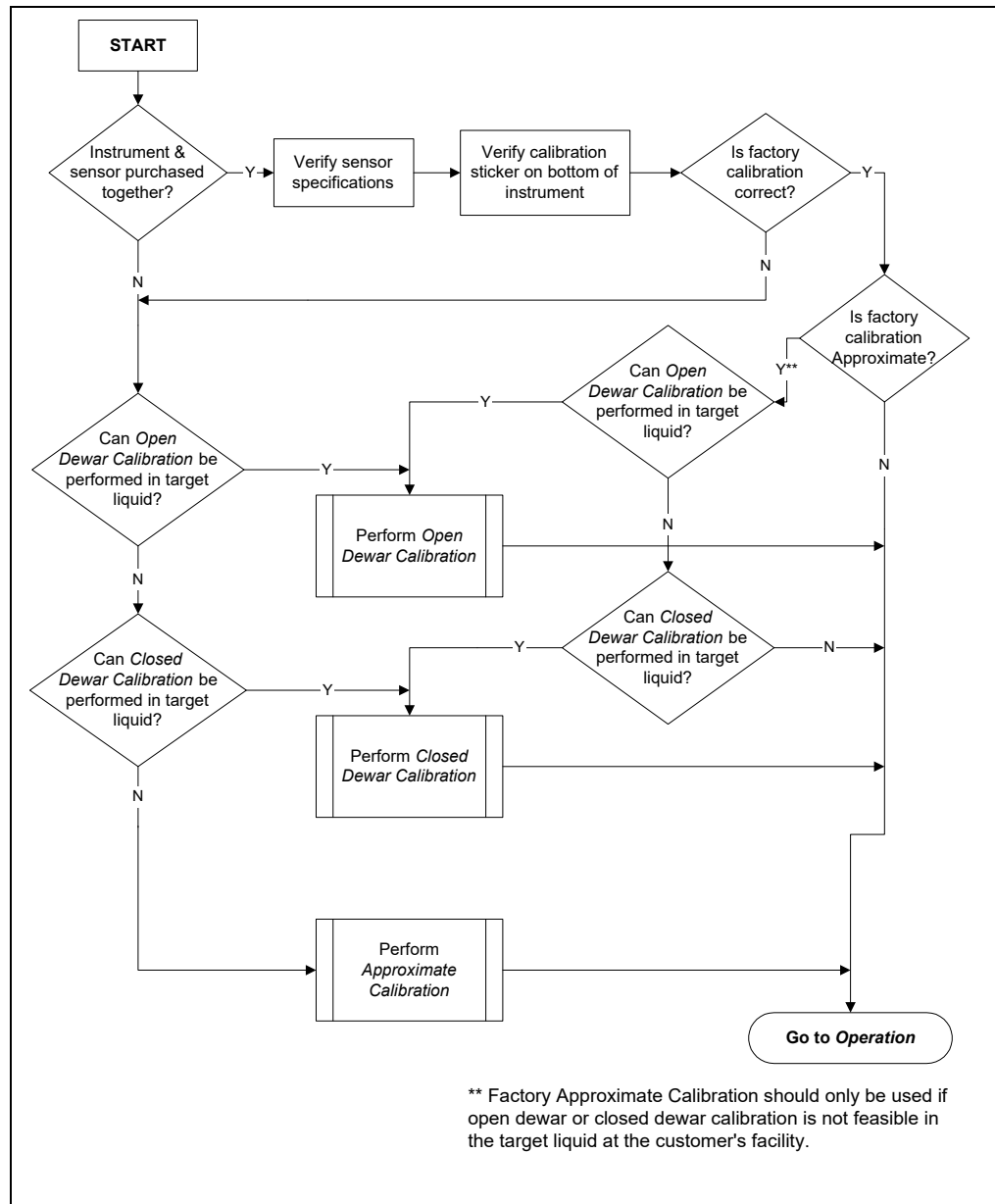

Calibration method selection diagram.

constants between liquid nitrogen and the desired liquid. The technique is intended to provide the instrument with an approximate calibration so that it can be used immediately by the customer. However, the customer is still expected to perform a more accurate calibration where feasible, such as the open dewar or closed dewar calibration, with the target liquid.

For the case where a sensor is too long to be calibrated in AMI facilities, AMI performs a partial length open dewar calibration in liquid nitrogen, and then calculates the maximum calibration point. A dielectric ratio (i.e.

approximate calibration factor) may also be subsequently used to adjust for a target liquid other than liquid nitrogen. The customer is expected to perform a more accurate open dewar or closed dewar calibration if feasible.

**PRE-CALIBRATION
PROCEDURE**

ENTER CAPACITANCE SENSOR INFORMATION

1. Press the **MENU** button in the lower left corner of the display screen.

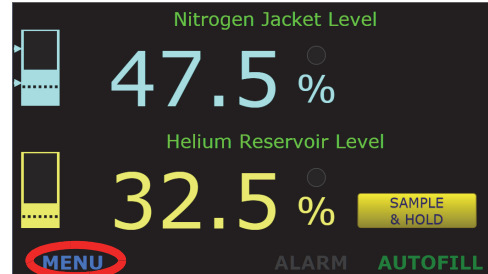

MENU Selection Button

2. Choose the **SENSORS** selection from the **MENU** screen.
3. If the capacitance sensor will be longer than 15 feet from the instrument, ensure an Oscillator/Transmitter is used between the instrument and the sensor.

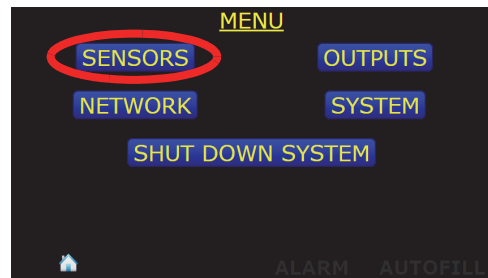

SENSORS Selection Button

4. Verify that the oscillator source selection is correct, either **INTERNAL** or **EXTERNAL**. Note that this setting is auto-detected by the instrument,

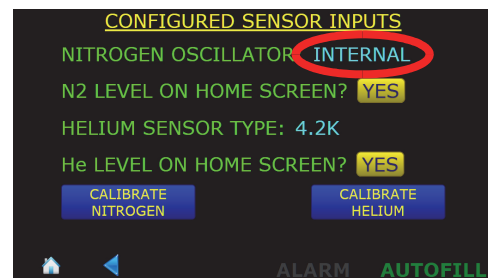

NITROGEN OSCILLATOR Selection

5. Press the **CALIBRATE NITROGEN** button

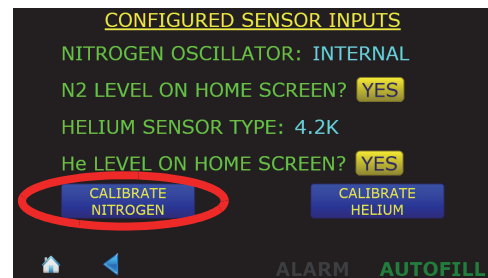

CALIBRATE NITROGEN Selection Button

- 6. Touch in the **SENSOR ACTIVE LENGTH** field and using the numerical keypad, enter the sensor active length in cm. Press **Enter** and then **SAVE** at the bottom of the screen when finished

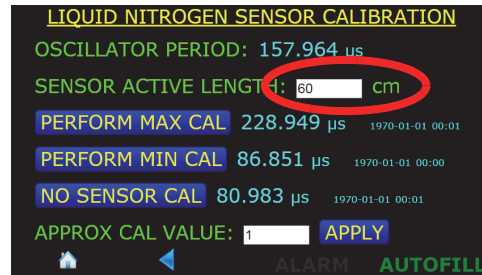

SENSOR ACTIVE LENGTH field

- 7. Press the back button in the screen footer twice to revert back to the **MENU** screen.

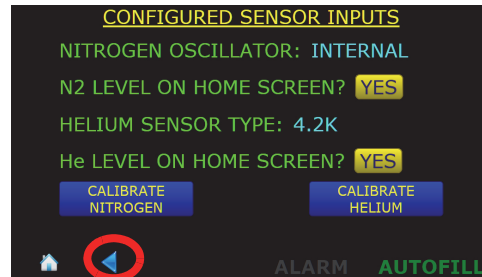

Footer BACK Button Selection

- 8. Press the **SYSTEM** button.

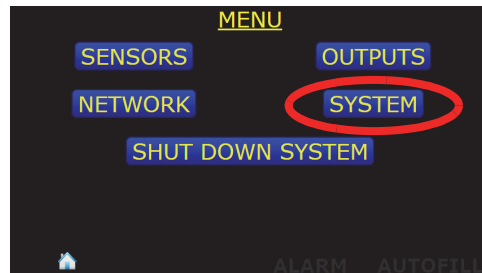

SYSTEM Menu Selection

- 9. Touch in the **NITROGEN SENSOR NAME:** field. The keyboard will be displayed. Edit the displayed name and press **ENTER** at the bottom of the screen.

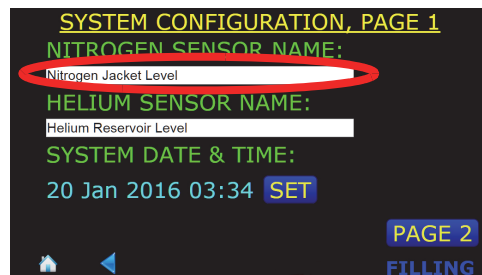

PERFORM MAX CAL. Selection Button

10. Press the home icon button in the screen footer to return to the level display screen.
- 11.

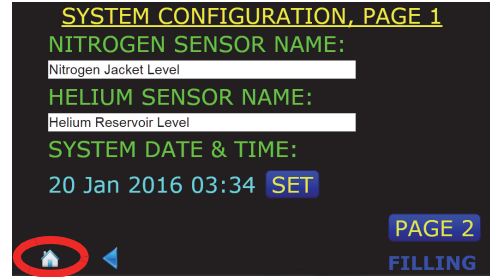

Home Selection Button

PERFORMING LOSS OF SENSOR CALIBRATION

The Model 1700 will detect when the liquid level sensor has been disconnected from the instrument and display a notification on the front panel. If the instrument has been configured for autofill, the fill valve will be shut, requiring operator intervention to resume autofill operation. This loss of sensor threshold must be calibrated as follows:

For a system where the internal oscillator is used, connect the coaxial cable to the BNC connector on the instrument rear panel but leave the cable disconnected from the sensor BNC connector. For a system where an external oscillator is used, connect the coaxial cable between the instrument and the oscillator/transmitter unit. Connect the second (6') coaxial cable to the input of the oscillator/transmitter unit but leave the cable disconnected from the sensor BNC connector.

1. Press the **MENU** button in the lower left corner of the display screen.

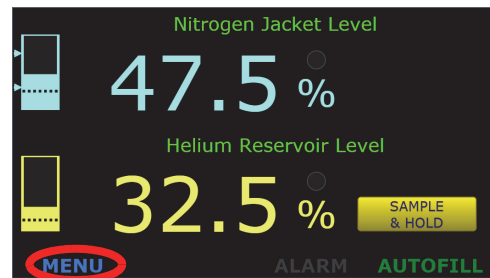

MENU Selection Button

- Choose the **SENSORS** selection from the **MENU** screen.

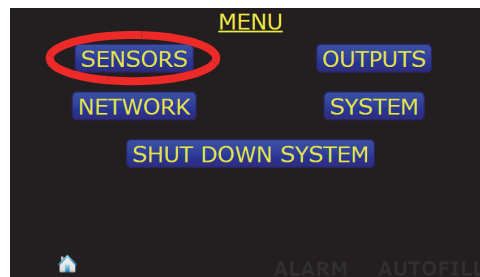

SENSORS Selection Button

- From the **SENSORS** Menu, choose **CALIBRATE NITROGEN**.

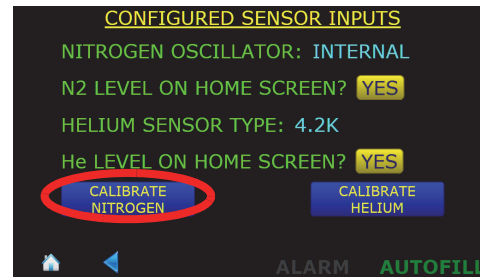

CALIBRATE NITROGEN Selection Button

- Select the **NO SENSOR CAL** button.
- When the calibration procedure is completed, choose **SAVE** in the footer of the screen.
- Press on the home icon to return to the home screen.
- Connect the BNC cable to the liquid level sensor.

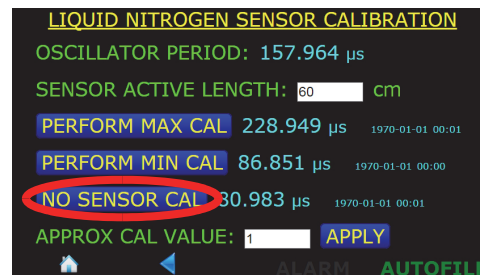

NO SENSOR CAL button

PERFORMING AN OPEN DEWAR CALIBRATION

The *Open Dewar Calibration* requires the customer to have access to a filled dewar where the full active length of the sensor can be dipped.

- Press the **MENU** button in the lower left corner of the display screen.

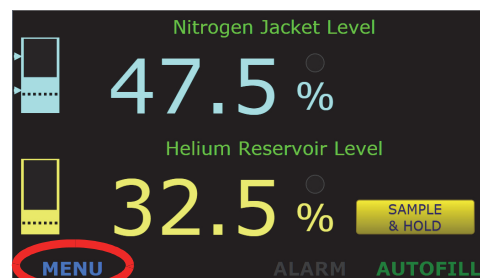

MENU Selection Button

- Choose the **SENSORS** selection from the **MENU** screen.

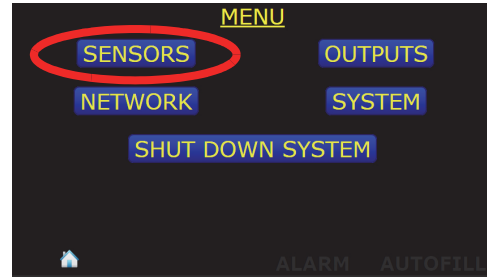

SENSORS Selection Button

- Press the **CALIBRATE NITROGEN** button

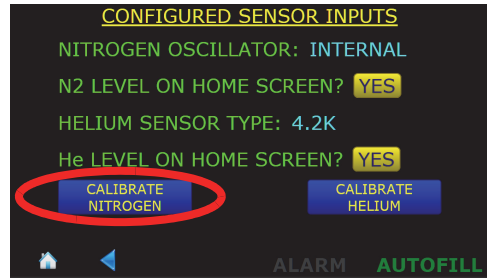

CALIBRATE NITROGEN Selection Button

- Position the capacitance sensor in the target liquid at the 100% level. Hold the sensor at this location and press the **PERFORM MAX CAL** button.

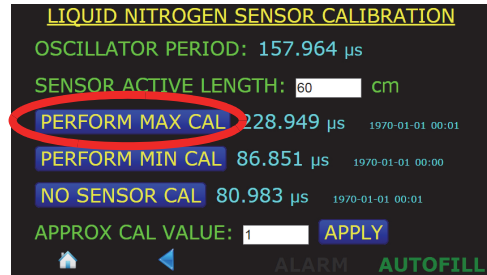

PERFORM MAX CAL. Selection Button

- The instrument will display the following screen as it takes data for several seconds. Once the calibration measurement is completed, press the **SAVE** button.

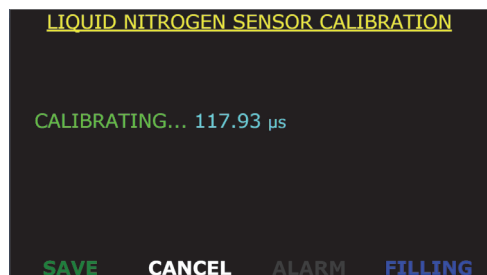

Updated MAX CAL Frequency

- Position the capacitance sensor in the target liquid at the 0% level. Hold the sensor at this level and press the **PERFORM MIN CAL** button.
- After several seconds of displaying “**CALIBRATING...**”, the instrument will complete the calibration process. Press the **SAVE** button to save the new calibration set point.

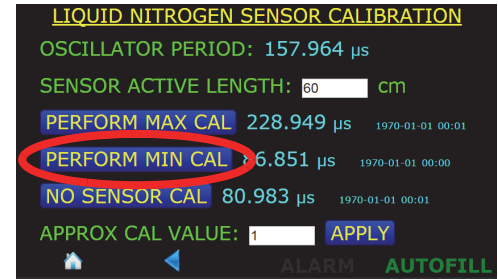

PERFORM MIN CAL. Selection Button

NOTE Note that the frequencies listed to the right of the **PERFORM MAX** and **MIN CAL** buttons are updated as well as the date and time stamps of the calibration points.

NOTE The Minimum and Maximum calibration can be performed in either order. Also, either the Minimum or Maximum calibration point can be updated without altering the other calibration point.

CLOSED DEWAR CALIBRATION

A calibration can be performed in a closed dewar system by monitoring the liquid level while transferring the target liquid to an initially empty (or near empty) dewar at a constant rate. In order to insure success with the closed dewar technique, it is necessary to prepare the instrument by presetting the calibration minimum and maximum calibration points outside the estimated level range. If the instrument is not prepared in this manner before the calibration procedure, it is possible to reach the maximum calibration point of the instrument before the target vessel is at the desired maximum level point. If minimum and maximum liquid level indication is available via some other means (e.g. flow calculation, visual determination, point sensors, etc.), then the presetting of the instrument is not necessary.

PRESETTING THE MAXIMUM AND MINIMUM CALIBRATION POINTS

The following procedure should be performed before installation of the sensor in the target cryo-vessel.

- Connect the sensor coaxial cable to the BNC connector on the rear panel of the instrument (Refer to “Connecting the Sensors to the Instrument” on page 14.). *Do not connect the sensor.* Energize the instrument.

2. Press the **MENU** button in the lower left corner of the display screen.

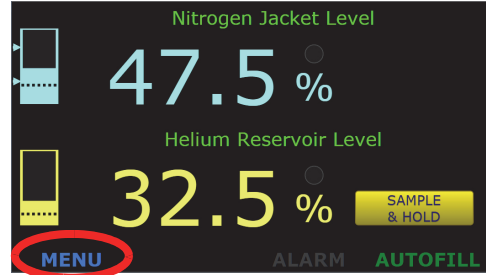

MENU Selection Button

3. Choose the **SENSORS** selection from the **MENU** screen.

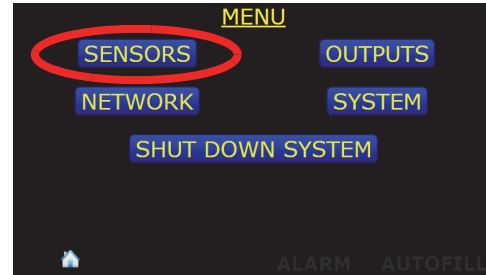

SENSORS Selection Button

4. Press the **CALIBRATE NITROGEN** button

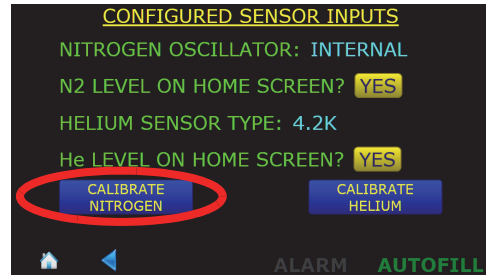

CALIBRATE NITROGEN Selection Button

5. Press the **PERFORM MIN CAL** button.

6. After several seconds of displaying “**CALIBRATING...**”, the instrument will complete the calibration process. Press the **SAVE** button to save the new calibration set point.

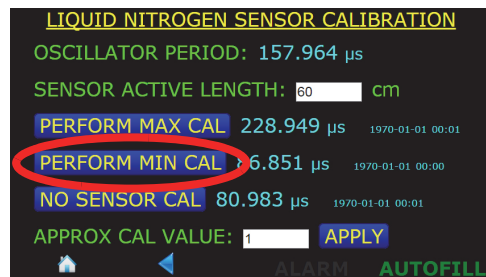

PERFORM MIN CAL. Selection Button

NOTE Note that the frequency listed to the right of the **PERFORM MIN CAL** button is updated as well as the date and time stamp of the calibration point.

7. Connect the sensor to the oscillator coaxial cable that is connected to the instrument.

- Perform the maximum level calibration by invoking the maximum calibration function by pressing **MENU > SENSORS > CALIBRATE NITROGEN > PERFORM MAX CAL.**

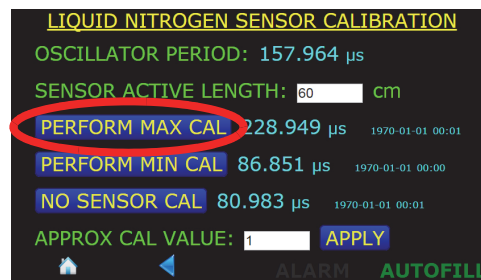

PERFORM MAX CAL. Selection Button

- Save the calibration value.
- Calculate the factor C_{adj} using the following equation:

$$C_{adj} = 120 \left[1 + \frac{2.1(L_{active})}{5.2(L_{total})} \right] \left[\frac{e - 1}{0.454} \right]$$

where L_{total} is the total sensor length in inches, L_{active} is the active sensor length in inches, and e is the dielectric constant of the target liquid.

- Enter C_{adj} into the instrument by touching the **APPROX CAL VALUE:** field.

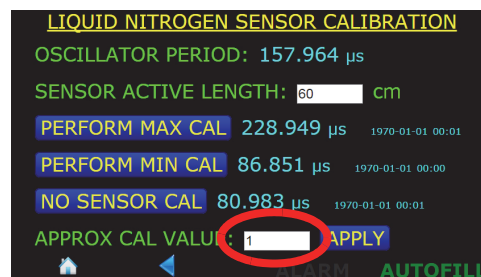

PERFORM MAX CAL. Selection Button

- Using the pop up numeric keypad, enter the C_{adj} value and press the **APPLY** button.
- With the sensor connected, again press the **PERFORM MIN CAL** button. The pre-setting procedure is complete. Proceed to the remainder of the closed dewar calibration procedure as presented below.

COMPLETING THE CLOSED DEWAR CALIBRATION PROCEDURE

- Install the sensor in the dewar and energize the instrument with the sensor connected to the instrument via the oscillator (if required) and extension cable(s) (see the system diagram on page 2).
- Connect a strip chart recorder or graphical data logging application to the recorder output terminals on the rear panel of the instrument. If the recorder output is not available, the 4-20 mA current loop output may be used if installed, or an installed communications option can be used to query the instrument for the liquid level at regular time intervals during the calibration procedure. If no remote monitoring or communication option is installed, the level display must be manually plotted vs. time during the procedure.
- Refer to “Analog output signals” on page 42. to configure the recorder output or current loop output.
- Commence filling the dewar. While the sensor is cooling down, there may be a slow drift in the displayed liquid level. However, when the liquid actually touches the bottom of the sensor, contact with the liquid surface may become apparent by virtue of more random and frequent fluctuations in the

displayed liquid level. The liquid level trace will also start to show an increasing profile with positive slope.

Once the indications of the contact between the sensor and liquid become readily apparent, use the **PERFORM MIN CAL** procedure below to reset the new minimum calibration point. This point is the 0% level of the sensor when the **PERFORM MIN CAL** procedure is finished and saved becomes the 0% level.

NOTE If the sensor is installed in the dewar with some small amount of liquid already in contact with the sensor, then the final minimum calibration point can be set before filling begins but after any thermally induced fluctuations in the observed output have diminished. However, note that the measured span of the liquid level is reduced by the initial level of liquid in contact with the sensor.

5. Perform the minimum level calibration by invoking the minimum calibration function by pressing **MENU > SENSORS > CALIBRATE NITROGEN > PERFORM MIN CAL**.
6. After several seconds of displaying “**CALIBRATING...**”, the instrument will complete the calibration process. Press the **SAVE** button to save the new calibration set point.

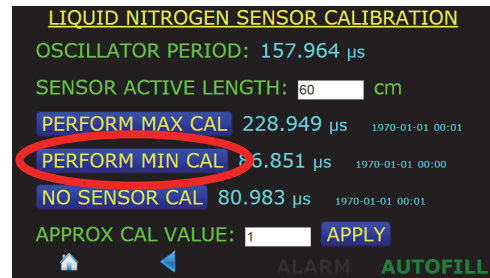

PERFORM MAX CAL. Selection Button

NOTE Note that the frequency listed to the right of the **PERFORM MIN CAL** button is updated as well as the date and time stamp of the calibration point.

7. Continue the transfer while observing the liquid level trace on the strip chart recorder or computer display, whose slope is proportional to the transfer rate. The slope of the liquid level trace should decrease significantly when the liquid reaches the hole in the top of the sensor.

When the break in the slope of the level trace occurs (i.e. the slope of the level trace becomes 0 or horizontal), perform a **PERFORM MAX CAL** procedure below. The level on the sensor when the **PERFORM MAX CAL** procedure is finished and saved becomes the 100% level.

NOTE If the instrument displayed a 100% reading before a break is observed in the slope of the level trace, then the maximum calibration point set prior to the current procedure has interfered. If this occurs, the customer has two options: 1) stop the procedure, repeatedly enter a value of 120 for C_{adj} (see steps 4 and 5 of the presetting procedure) until the current liquid level display falls below 100%, and then continue the procedure; or 2) continue the liquid transfer until the liquid level is determined to be 100% by means other than feedback from the instrument and then performing the maximum calibration procedure.

8. Perform the maximum level calibration by invoking the maximum calibration function by pressing **MENU > SENSORS > CALIBRATE NITROGEN > PERFORM MAX CAL.**

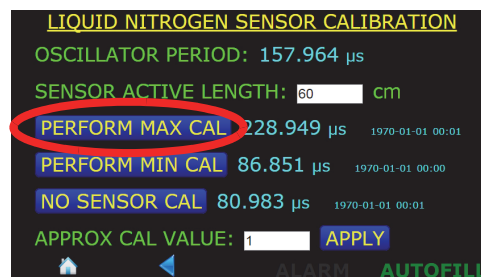

PERFORM MAX CAL. Selection Button

9. The instrument will display the following screen as it takes data for several seconds. Once the calibration measurement is completed, press the **SAVE** button.

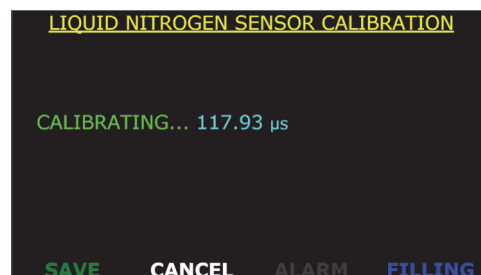

Updated MAX CAL Frequency

NOTE Note that the frequency listed to the right of the **PERFORM MAX CAL** button is updated as well as the date and time stamp of the calibration point.

10. To achieve a standard calibration of the sensor with the active region located from the lower hole to one inch below the upper hole, use the level data from the instrument to recalibrate the maximum point when the percent level corresponds to one inch below the upper hole. Use the following equation to determine the percent level at which to reset the maximum calibration point:

$$MAX_{percent} = 100 - 100 \left[\frac{1}{L_{active}} \right]$$

where L_{active} is the active length of the sensor in inches. This technique can be used assuming the sensor was built as a standard sensor. If the sensor

was made in a custom configuration, refer to the sensor documentation and/or drawing or contact AMI.

Example: 20" active length sensor:

When the sensor is calibrated by the closed dewar procedure, the actual length of calibration will be 21" (distance between the bottom and top holes in the sensor). When the liquid is 1" below the upper hole, the display will show 95.2% [e.g. $100\% - (1"/21" \times 100\%)$]. When the liquid level reaches this point during usage, perform the **PERFORM MAX CAL** operation. The instrument and sensor are now calibrated with a standard active region of 20". The length setting of the sensor in the instrument should also be configured for 50.8 cm (20").

APPROXIMATE CALIBRATION

This procedure is the least accurate form of calibration and should be used only when the aforementioned calibration procedures are not viable. The approximate calibration method can be used in cases where the sensor cannot be dipped into the target liquid, the full active length of the sensor cannot be dipped into an open dewar, or both. Approximate calibration may also be useful for situations where the sensor cannot be dipped into the target liquid under the expected operating pressure.

If the target liquid is not available for dipping, a substitute non-conducting reference liquid can be used. If the full length of the sensor cannot be dipped, then a partial length dip can be performed. If both situations are encountered, then a partial length dip can be performed in a substitute reference liquid.

1. Press the **MENU** button in the lower left corner of the display screen.

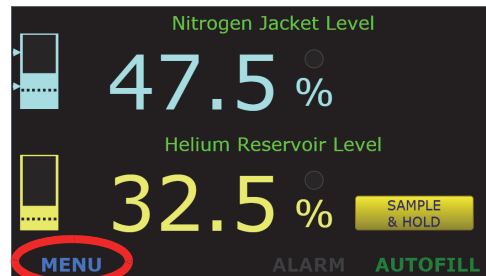

MENU Selection Button

2. Choose the **SENSORS** selection from the **MENU** screen.

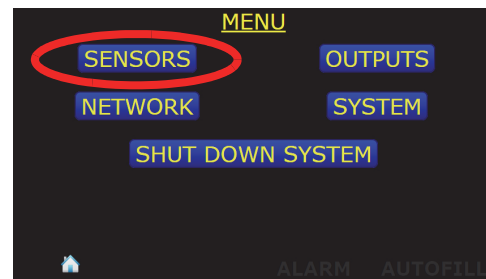

SENSORS Selection Button

3. Press the **CALIBRATE NITROGEN** button

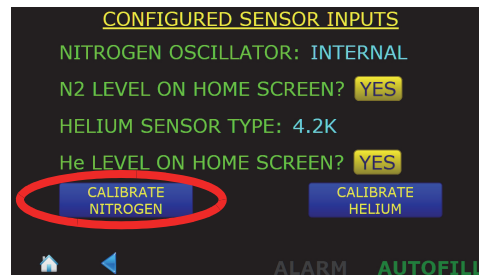

CALIBRATE NITROGEN Selection Button

4. Position the capacitance sensor in the target liquid at the 100% level. Hold the sensor at this location and press the **PERFORM MAX CAL** button.

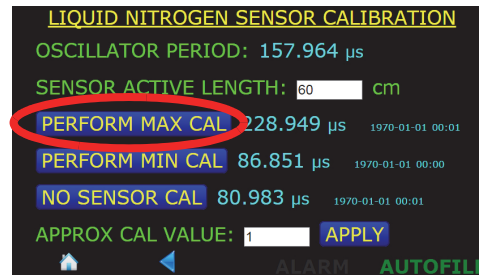

PERFORM MAX CAL. Selection Button

5. The instrument will display the following screen as it takes data for several seconds. Once the calibration measurement is completed, press the **SAVE** button.

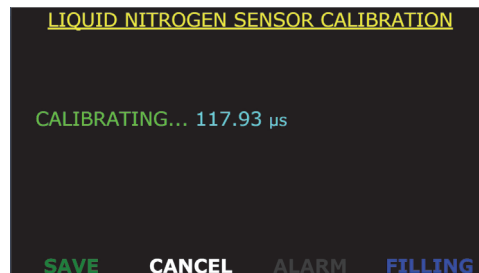

Updated MAX CAL Frequency

6. Position the capacitance sensor in the target liquid at the 0% level. Hold the sensor at this level and press the **PERFORM MIN CAL** button.

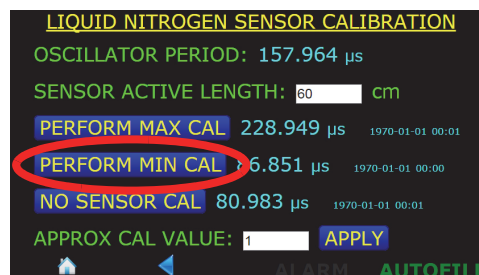

PERFORM MIN CAL. Selection Button

7. After several seconds of displaying "CALIBRATING...", the instrument will complete the calibration process. Press the **SAVE** button to save the new calibration set point.

NOTE Note that the frequencies listed to the right of the **PERFORM MAX** and **MIN CAL** buttons are updated as well as the date and time stamps of the calibration points.

NOTE The Minimum and Maximum calibration can be performed in either order. Also, either the Minimum or Maximum calibration point can be updated without altering the other calibration point.

8. Measure the distance between the bottom hole of the sensor and the location of the liquid level dipped for max calibration. This measured length is L_{dipped} .
9. The dielectric constant for the reference liquid, e_1 , and the target liquid, e_2 , must be known to complete the approximate calibration. These values must be placed in the equation:

$$\text{Approximate Calibration Factor} = \left[\frac{e_2 - 1}{e_1 - 1} \times 100 \right] \frac{L_{active}}{L_{dipped}}$$

where L_{dipped} is the length of the sensor dipped in the reference liquid and L_{active} is the active sensor length.

NOTE If the target liquid is available for dipping (i.e. the reference liquid and target liquid are the same), then the dielectric ratio, $(e_2 - 1) / (e_1 - 1)$, becomes 1. If the full active length of the sensor can be dipped, then the length ratio, L_{active} / L_{dipped} , becomes 1.

Note that $e_1 = 1.454$ for liquid nitrogen at -203°C at atmospheric pressure. Dielectric constants for several liquids are provided in the Appendix. The dielectric constant varies with temperature and pressure, therefore for best accuracy use the dielectric constant for the target liquid at the temperature and pressure maintained in the containing vessel.

10. Touch the **APPROX. CAL. VALUE**: field and using the numerical keypad that pops up, enter the Approx Cal Value to be applied.

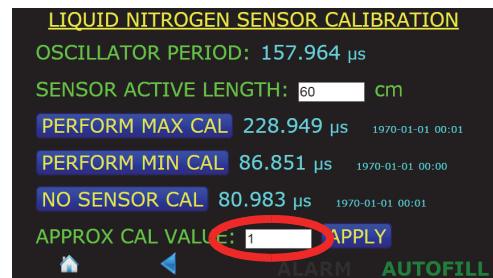

APPROX. CAL. VALUE field

11. Press the **APPLY** button and note that the Approximate Calibration value will be used to scale the **MAX** Calibration frequency displayed adjacent to the **PERFORM MAX CAL** button and the value entered into the **APPROX. CAL. VALUE** field will vanish.

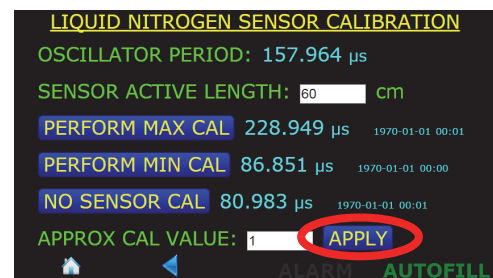

MAX CAL values edited

NOTE The last approximate calibration factor is not retained in the instrument memory, therefore the effects of repeated approximate calibrations are cumulative.

Example: Purchased a 100" active length sensor for operation in liquid argon at atmospheric pressure, however only liquid nitrogen is available for calibration at a maximum depth of 30":

First, the sensor is dipped as far as possible into the liquid nitrogen and cooled. The minimum point is then set as outlined in step 2. The maximum point is set as outlined in step 3 while the sensor is submerged 30" in liquid nitrogen. The dielectric constant for liquid nitrogen is 1.454 and for liquid argon is 1.53. Substituting all values into the approximate calibration factor equation yields:

$$\text{Approximate Calibration Factor} = \left[\frac{1.53 - 1}{1.454 - 1} \right] \frac{100}{30} = 3.891$$

A value of 3.891 would be entered as the approximate calibration factor as outlined in steps 6 and 7. The sensor is now approximately calibrated for 100" active length operation in liquid argon.

12. The sensor can now be installed in the dewar containing the target liquid. The approximate calibration can be used until an open dewar or closed dewar calibration can be performed with the target liquid.

Proceed to the *Operation* section for directions for configuring the instrument.

SUPERCONDUCTIVITY-BASED (LIQUID HELIUM) LEVEL CALIBRATION

The instrument has been calibrated for Liquid helium Sensors at the AMI facility. No further calibration is needed.

However, to have the Model 1700 Instrument work correctly, at a minimum, the user must enter the correct active length for the sensor.

NOTE If the instrument was purchased with a helium level sensor, the active length will be set prior to shipping.

VERIFY THE LIQUID HELIUM SENSOR TYPE

1. Press the **MENU** button in the lower left corner of the display screen.

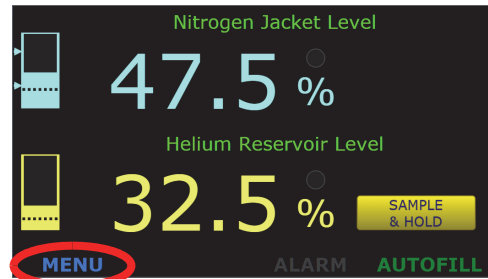

Home Screen

2. Choose the **SENSORS** button from the **MENU** screen.

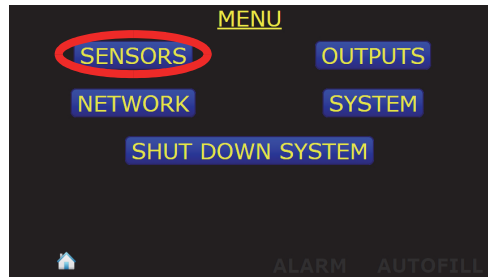

MENU Selection Button

3. Verify that the **HELIUM SENSOR TYPE**: (either **4.2K** or **2K** is correct for the sensor to be used with the instrument. If not, contact the factory for assistance.

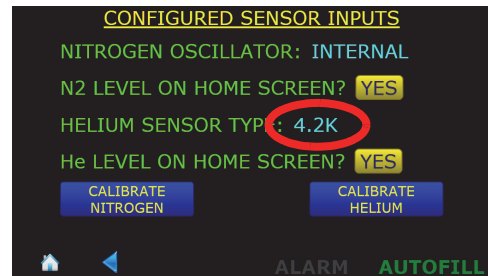

SENSORS Selection Button

SENSOR SAMPLE INTERVAL

1. Press the **MENU** button in the lower left corner of the display screen.

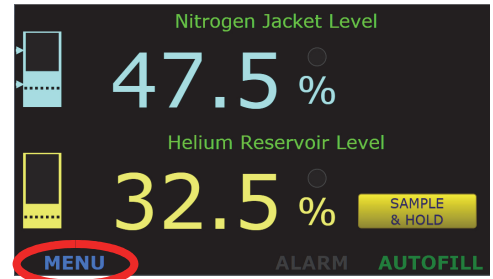

Home Screen

2. Choose the **SENSORS** button from the **MENU** screen.

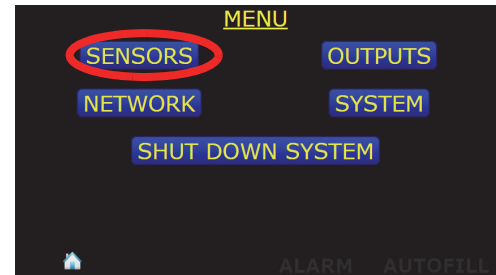

MENU Selection Button

3. Choose the **CALIBRATE HELIUM** selection.

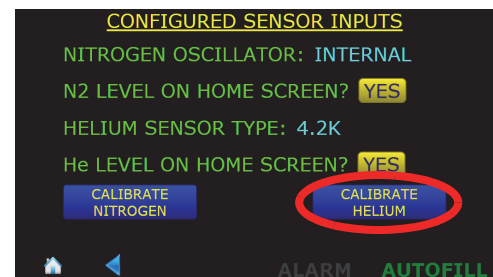

SENSORS Selection Button

4. Press in the **SENSOR SAMPLE INTERVAL** field. A pop up numeric keypad will be launched.

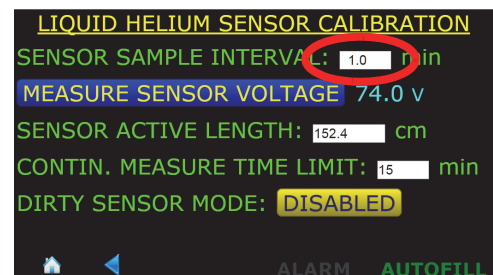

Enter Liquid Helium Sensor Active Length

5. Enter the desired sample interval time in minutes and press **Enter** and then **SAVE**.

SENSOR ACTIVE LENGTH

1. Press in the **SENSOR ACTIVE LENGTH** field. A pop up numeric keypad will be launched.
2. Enter the **SENSOR ACTIVE LENGTH** in centimeters and press **Enter** and then **SAVE**.

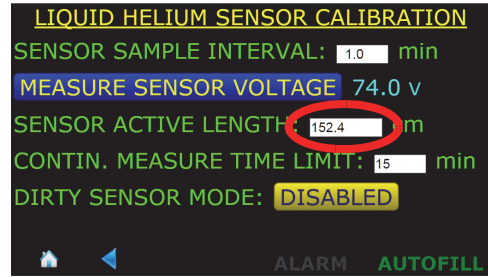

Enter Liquid Helium Sensor Active Length

CONTINUOUS MEASURE TIME LIMIT

The Continuous measure time limit feature sets a maximum time that the instrument will keep the liquid helium level sensor energized. If the instrument is left in the **CONTINUOUS** mode for the **CONTIN. MEASURE TIME LIMIT** interval, the instrument will revert back to the Sample and Hold mode to prevent excessive liquid helium boil off.

1. Press in the **CONTIN. MEASURE TIME LIMIT** field. A pop up numeric keypad will be launched.
2. Enter the maximum time in minutes that the sensor should remain energized in the continuous mode.
3. Press **ENTER** on the keypad and then **SAVE** at the bottom of the screen.
4. Press the back button in the screen footer twice to revert back to the **MENU** screen.

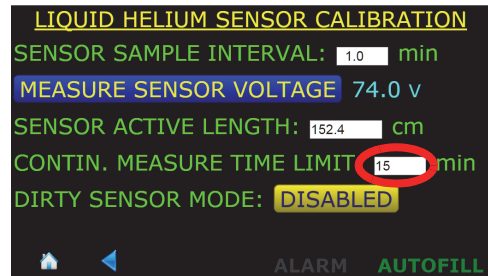

Enter Liquid Helium Sensor Active Length

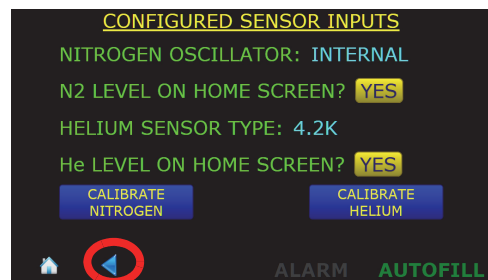

Footer BACK Button Selection

SENSOR NAME

1. Press the **SYSTEM** button.

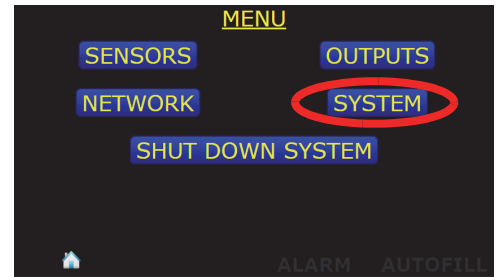
**SYSTEM Menu Selection**

2. Touch in the **HELIUM SENSOR NAME:** field. The keyboard will be displayed. Edit the displayed name and press **ENTER** and then **SAVE** at the bottom of the screen.

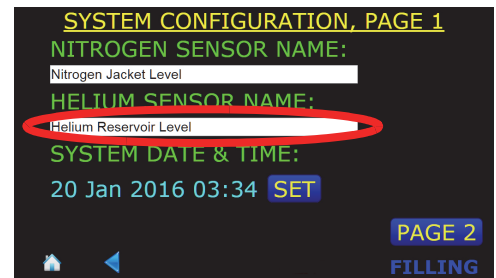
**HELIUM SENSOR NAME: Field**

3. Press the home icon button in the screen footer to return to the level display screen.

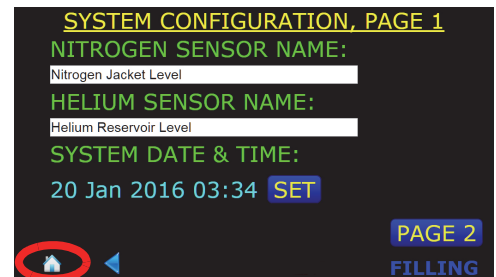
**Home Selection Button**

REMOTE INTERFACE REFERENCE

The Model 1700 Instrument provides both serial (RS-232) and Ethernet interfaces as standard features. The serial and Ethernet interfaces can be operated simultaneously. Separate output buffers are provided for the serial and Ethernet return data. The serial and Ethernet interfaces accept SCPI syntax for commands and queries.

The Model 1700 provides a web browser connection (port 80) via TCP/IP and presents a mirror of the local display which has hot spots that can be clicked or tapped, and which also accepts keyboard entry for textual and numerical input. The instrument's IP address can be ascertained by referring to the section titled "IP Addressing Scheme" on page 42. By using a web browser to connect to the instrument, all functionality of the Model 1700 can be controlled via the remote connection.

Communication with the Model 1700 via Ethernet or RS-232 (serial) interface can also be accomplished via the interactive mode of a commercially available terminal emulation program, or by socket (port 7180) or COM port programming. When the Model 1700 receives a terminated ASCII string, it always sends back a reply as soon as the string is processed. *When sending commands to the Model 1700, you should wait for the reply from the Model 1700 before sending another command even if the reply consists of only termination characters.*

SCPI COMMAND SUMMARY

The following manual conventions are used for SCPI (*Standard Commands for Programmable Instruments*) syntax for the remote interface commands:

- Braces { } enclose valid parameter choices.
- A vertical bar | separates multiple choices for each parameter.

- Triangle brackets < > indicate that you must supply a value.
- Parentheses () within < > indicate alternative units are available.

For example, the command `CONFigure:RELAY1:CHannel {0|1|2}` indicates that the command `CONFigure:RELAY1:CHannel` has three parameter options: 0, 1, or 2, with 0 (disabled) being the default value.

The following section is a reference list of SCPI commands. Refer to the detailed description of each command for information regarding specific parameter choices and their meanings. Capitalized portions of the commands indicate acceptable abbreviations. Default settings are shown in bold.

System-Related Commands

(see page 80 for more information)

*IDN?

N2?

HE?

SERial_NUMBER?

DATE_MANUFACTure?

HardWare_VERSion?

FirmWare_VERSion?

SYStem:BEEPer:IMMediate <*seconds*>

SYStem:BEEPer:STATe {0|1}

SYStem:KLOCK {0|1}

SYStem:KLOCK?

SYStem:DATE <yyyy>,<mm>,<dd>

SYStem:DATE?

SYStem:TIME <hh>,<mm>,<ss>

SYStem:TIME?

SYStem:REBOOT

SYStem:RESTORE

IPV4ADDR

MACADDR

Display Configuration Commands and Queries*(see page 82 for more information)*

```

DISPLAY:N2?
CONFigure:NAME:SENSor:N2 "<string>"
NAME:SENSor:N2?

DISPLAY:HE?
CONFigure:NAME:SENSor:HE "<string>"
NAME:SENSor:HE?

```

Alarm Configuration Commands and Queries*(see page 83 for more information)*

```

CONFigure:RELAY1:CHannel {0|1|2}
RELAY1:CHannel?

CONFigure:RELAY1:SETpoint <level>
RELAY1:SETpoint?

CONFigure:RELAY1:OPeration {0|1}
RELAY1:OPeration?

CONFigure:RELAY2:CHannel {0|1|2}
RELAY2:CHannel?

CONFigure:RELAY2:SETpoint <level>
RELAY2:SETpoint?

CONFigure:RELAY2:OPeration {0|1}
RELAY2:OPeration?

```

Measurement Commands and Queries*(see page 84 for more information)*

```

MEASure:N2:LEVel?
MEASure:N2:PERIod?

MEASure:HE:LEVel?
MEASure:HE:HOLD
MEASure:HE:CONTinuous
MEASure:HE:SAMPle

```

MEASure:HE:VOLTage?

MEASure:ADC0?

MEASure:ADC1?

MEASure:ADC2?

Fill Control and Queries

(see page 85 for more information)

CONFigure:FILL:CHannel {0|1|2}

FILL:CHannel?

CONFigure:FILL:A <level>

FILL:A?

CONFigure:FILL:B <level>

FILL:B?

CONFigure:INTerval:FILL <minutes>

N2:INTerval?

HE Channel Sampling Commands and Queries

(see page 88 for more information)

CONFigure:INTerval:SAMPlE <minutes>

HE:INTerval?

CONFigure:HE:TIME_limit <minutes>

HE:TIME_limit?

LOG_LHE {0|1}

LOG_LHE?

HElium_PowerSupply?

DIRTy_sen_mode?

Assignment Commands and Queries

(see page 87 for more information)

CONFigure:SOURCE:REC_out {0|1|2}

SOURCE:REC_out?

```
CONFigure:SOURCE:CURrent_LOOP {0|1|2}
SOURCE:CURrent_LOOP?
```

N2 Channel Calibration Commands and Queries

(see page 87 for more information)

```
CONFigure:N2:LENgth <value>
N2:LENgth?
MINCAL
MAXCAL
NOSENSorCAL
```

HE Channel Calibration Commands and Queries

(see page 88 for more information)

```
CONFigure:HE:LENgth <value>
HE:LENgth?
```

Remote Units Commands and Queries

(see page 88 for more information)

```
CONFigure:N2:UNIT {0|1|2} or {PERCENT|CM|INCH}
N2:UNIT?
```

```
CONFigure:HE:UNIT {0|1|2} or {PERCENT|CM|INCH}
HE:UNIT?
```

RS-232 CONFIGURATION

An RS-232 serial communication port is available as a 9-pin D-type connector on the rear panel of the instrument for serial communication function.

The Model 1700 uses the following *fixed* parameters related to the RS-232 interface:

- *Baud Rate*: 115200
- *Parity*: No Parity
- *Data Bits*: 8 Data Bits
- *Number of Start Bits*: 1 bit

- *Number of Stop Bits*: 1 bit
- *Flow Control*: None

SERIAL PORT CONNECTOR AND CABLING

A PC-compatible computer's serial port can be directly connected to the Model 1700 via a standard USB-to-serial cable. Refer to the computer's documentation to determine which ports are available on a computer and the required connector type.

The Model 1700 uses only three wires of the rear-panel DB9 connector: pin 2 (transmit), pin 3 (receive), and pin 7 (common). There are no software or hardware handshaking options. The Model 1700 is classified as a DCE (Data Communication Equipment) device since it transmits data on pin 3 and receives data on pin 2. The instrument to which the Model 1700 is attached must do the opposite, i.e., transmit on pin 2 and receive on pin 3 (the requirements for a DTE, or Data Terminal Equipment device).

COMMAND/RETURN TERMINATION CHARACTERS

All commands are transmitted and received as ASCII values and are case insensitive. The Model 1700 always transmits `<CR><LF>` (i.e. a *carriage return* followed by a *linefeed*) at the end of a transmission. The Model 1700 can accept `<CR>`, `<LF>`, `<CR><LF>`, or `<LF><CR>` as termination characters from an external computer.

ETHERNET CONFIGURATION

The Model 1700 provides a 10/100Base-T Ethernet interface as a standard feature. It complies with the IEEE 802.3u 100Base-TX and 802.3 10Base-T standards.

The Model 1700 allows its IP address, subnet mask and gateway IP address to be assigned either statically or dynamically. To make these values static and assign them manually, set IP Address Assignment to Static (see page 42) and then set the values using the Edit parameter list. To enable the values to be dynamically assigned by a network DHCP server, set IP Address Assignment to DHCP.

The system name (also known as *host name* or *computer name*), can be set using remote communications (either Ethernet or RS-232); it cannot be edited using the front panel keypad.

All network parameters (even those assigned by a DHCP server) can be viewed using the Network submenu (see page 42).

ETHERNET CONNECTOR

The Model 1700 uses a standard RJ-45 jack for Ethernet communications. The Ethernet jack pinout is fully documented on page 98 in the *Appendix*.

**TERMINATION
CHARACTERS**

All commands and queries are transmitted and received as ASCII values and are case insensitive. The Model 1700 always transmits <CR><LF> (a *carriage return* followed by a *linefeed*) at the end of an Ethernet transmission. The Model 430 can accept <CR>, <LF>, <CR><LF>, or <LF><CR> as termination characters from an external computer.

PORT ASSIGNMENT

The Model 1700 accepts remote connections to port 7180. Multiple connections to port 7180 are allowed.

COMMAND REFERENCE

All commands sent to the Model 1700 are processed and the Model 1700 responds with a return value (if applicable) and termination. If the command is invalid, the Model 1700 will respond with an error code (see the *Error Codes* section). All return values including error codes are terminated with `<CR><LF>` (i.e. a *carriage return* followed by a *linefeed*). For those commands that do not return a value, the Model 1700 will return the `<CR><LF>` termination only.

The remote units settings are saved in non-volatile memory and are restored at power-up.

The Model 1700 instrument may be configured for reading liquid nitrogen, liquid helium, or both. Some commands will not be applicable if the instrument is not configured for certain level measurement.

SYSTEM RELATED COMMANDS

- *IDN?

Returns the identification string of the Model 1700. The identification string contains the manufacturer name, model number, serial number, and firmware revision code. Example output:

```
AMERICAN MAGNETICS INC.,MODEL 1700,1700-16-002,2.4.32015
```

- N2?

Returns "0" if the instrument is not configured to read liquid nitrogen level, "1" if it is with the internal oscillator, and a "2" if it is with an external oscillator/transmitter.

- HE?

Returns "0" if the instrument is not configured to read liquid helium level, "1" if the instrument is configured to read 4.2K liquid helium level for sensors of active length ≤ 40 inches, "2" if the instrument is configured to read 4.2K liquid helium level for sensors of active length ≤ 80 inches, "3" if the instrument is configured to read 2K liquid helium level for sensors of active length ≤ 40 inches, or "4" if the instrument is configured to read 2K liquid helium level for sensors of active length ≤ 80 inches.

- SERIAL_NUMBER?

Returns the serial number of the instrument as a string, for example: 1700-16-002.

- DATE_MANUFACTURE?

Returns the date of manufacture as a string in the form *yyyy-mm-dd*, for example: 2016-11-30.

- HARDWARE_VERSION?

Returns the hardware version of the instrument.

- FIRMWARE_VERSION?

Returns the firmware version of the instrument, for example: 2.4.32015.

- SYSTEM:BEEPER:IMMEDIATE *<seconds>*

The receipt of this command with a valid argument causes an audible tone to be generated by the instrument. The duration time parameter is specified in seconds.

- SYSTEM:BEEPER:STATE {0|1}

Enables/disables the beeper. When STATE "0" (OFF) is selected, no instrument condition, except the SYSTEM:BEEPER:IMMEDIATE command, shall cause an audible beep to be emitted. When the instrument restarts, this value is reset to a default of "1" (ON).

- SYSTEM:KLOCK {0|1}

This command locks the local controls of an instrument if set to a value of "1" (ON). This includes all front panel, keyboard, or other local interfaces. The state of the lock defaults to "0" (OFF) when the instrument is restarted.

- SYSTEM:KLOCK?

Returns the state of the instrument local controls lock. A return value of "0" indicates the lock is OFF. A return value of "1" indicates the local interfaces, such as the touch display, of the instrument are locked.

- SYSTEM:DATE *<yyyy>*,*<mm>*,*<dd>*

Sets the date per *<yyyy>* as a four-digit number; *<mm>* month with range of 1 to 12 inclusive; *<dd>* day of the month. This command requires escalated rights and therefore is only available via the serial port for which access can be controlled.

- SYSTEM:DATE?

Returns the system date if the form *<yyyy>*,*<mm>*,*<dd>*.

- SYStem:TIME <hh>,<mm>,<ss>

This command is used to set the instrument's clock:

- <hh> Range of hours is 0 to 23 inclusive.
- <mm> Range of minutes is 0 to 59 inclusive.
- <ss> Range of seconds is 0 to 60.

The response will consist of the set time with three fields separated by commas: <hh>,<mm>,<ss>. This command requires escalated rights and therefore is only available via the serial port for which access can be controlled.

- SYStem:TIME?

Returns the system time if the form <hh>,<mm>,<ss>.

- SYStem:REBOOT

Reboots the instrument. This command requires escalated rights and therefore is only available via the serial port for which access can be controlled.

- SYStem:RESTORE

Reboots the instrument and sets all parameters back to factory defaults. This command requires escalated rights and therefore is only available via the serial port for which access can be controlled.

- IPV4ADDR

Returns the presently assigned TCP/IP version 4 address in the form:
xxx.xxx.xxx.xxx

- MACADDR

Returns the MAC address of the network interface.

DISPLAY CONFIGURATION COMMANDS AND QUERIES

- DISPLAY:N2?

Returns a "0" if the instrument is not configured to display liquid nitrogen level on the home screen and a "1" if it is.

- CONFigure:NAME:SENSor:N2 "<string>"

Sets the displayed name of the nitrogen level sensor.

- NAME:SENSOR:N2?

Returns the displayed name of the nitrogen level sensor.

- DISPLAY:HE?

Returns a "0" if the instrument is not configured to display liquid helium level on the home screen and a "1" if it is.

- CONFIGure:NAME:SENSOR:HE "<string>"

Sets the displayed name of the helium level sensor.

- NAME:SENSOR:HE?

Returns the displayed name of the helium level sensor.

ALARM CONFIGURATION COMMANDS AND QUERIES

- CONFIGure:RELAY1:CHannel {0|1|2}

Assigns relay №1 as disabled (0), or to nitrogen (1) or helium (2).

- RELAY1:CHannel?

Returns a "0" if relay №1 is disabled, a "1" if the relay is assigned to the nitrogen channel, and a "2" if the relay is assigned to the helium channel.

- CONFIGure:RELAY1:SETpoint <level>

Configures the relay №1 trip setpoint in the currently assigned channel's units.

- RELAY1:SETpoint?

Returns the Relay №1 setpoint in the current units.

- CONFIGure:RELAY1:OPeration {0|1}

Configures relay №1 such that it closes (alarms) when the level is \leq the setpoint (0) or \geq the setpoint (1).

- RELAY1:OPeration?

Returns a "0" if relay №1 closes (alarms) when the level is above the setpoint and a "1" if the relay closes (alarms) when the level is below the setpoint. By default, relay №1 is configured as a HI level relay with alarm condition when level is greater than the setpoint.

- `CONFigure:RELAY2:CHannel {0|1|2}`

Assigns relay №2 to disabled (0), or to nitrogen (1) or helium (2).

- `RELAY2:CHannel?`

Returns a "0" if relay №2 is disabled, a "1" if the relay is assigned to the nitrogen channel, and a "2" if the relay is assigned to the helium channel.

- `CONFigure:RELAY2:SETpoint <level>`

Configures the relay №2 trip setpoint in the currently assigned channel's units.

- `RELAY2:SETpoint?`

Returns the Relay №2 setpoint in the current units.

- `CONFigure:RELAY2:OPeration {0|1}`

Configures relay №2 such that it closes (alarms) when the level is \leq the setpoint (0) or \geq the setpoint (1)

- `RELAY2:OPeration?`

Returns a "0" if relay №2 closes (alarms) when the level is below the setpoint and a "1" if the relay closes (alarms) when the relay is above the setpoint. By default, relay №2 is configured as a LO level relay with alarm condition when level is less than the setpoint.

MEASUREMENT COMMANDS AND QUERIES

- `MEASure:N2:LEVel?`

Returns the liquid nitrogen level in the current units.

- `MEASure:N2:PERIod?`

Returns the liquid nitrogen level measurement period in microseconds.

- `MEASure:HE:LEVel?`

Returns the liquid helium level in the current units.

- `MEASure:HE:HOLD`

Changes liquid helium level measurement operation from Continuous to Sample and Hold.

- `MEASure:HE:CONTInuous`

Changes liquid helium level measurement operation from Sample and Hold to Continuous mode.

- `MEASure:HE:SAMPlE`

Energizes the liquid helium level sensor, makes a reading and returns to Sample and Hold mode.

- `MEASure:HE:VOLTage?`

Returns the last measured liquid helium level sensor voltage in volts.

- `MEASure:ADC0?`

Returns the last measured liquid helium level sensor voltage in volts.

- `MEASure:ADC1?`

Returns the liquid helium sensor power supply voltage in volts.

- `MEASure:ADC2?`

Returns the liquid helium sensor excitation current in milliamperes.

FILL CONTROL AND QUERIES

- `CONFigure:FILL:CHannel {0|1|2}`

Assigns the auto fill control relay to either no channel (disabled) (0), nitrogen (1), or helium (2).

- `FILL:CHannel?`

Returns a "0" if the auto fill relay is disabled, a "1" if the relay is assigned to the nitrogen channel, and a "2" if the relay is assigned to the helium channel.

- `CONFigure:FILL:A <level>`

Sets the A setpoint (control band upper limit) in the assigned channel's current units. The A setpoint (autofill stop) must be greater than the B setpoint (fill start) and must also be between 0% and 100%.

- `FILL:A?`

Returns the A setpoint (control band upper limit) in the assigned channel's current units.

- `CONFigure:FILL:B <level>`

Sets the B setpoint (control band lower limit) in the assigned channel's current units. The B setpoint (autofill start) must be less than the A setpoint (fill stop) and must also be between 0% and 100%.

- `FILL:B?`

Returns the B setpoint (control band lower limit) in the assigned channel's current units.

- `CONFigure:INTErval:FILL <minutes>`

Sets the N2 fill timer in minutes. If the level does not reach or exceed the A setpoint within the fill time, the fill is terminated. Setting the value of FILL to "0" disables the fill timer function. The fill timer is not available for the helium level channel.

- `N2:INTErval?`

Returns the fill timer setting in minutes if the instrument is configured for the nitrogen channel.

HE CHANNEL SAMPLING COMMANDS AND QUERIES

- `CONFigure:INTErval:SAMPlE <minutes>`

Sets the liquid helium sampling interval in minutes.

- `HE:INTErval?`

Returns the sampling interval in minutes if the instrument is configured with a helium channel.

- `CONFigure:HE:TIME_limit <minutes>`

Sets the continuous measurement time limit for liquid helium measurements in minutes, after which time the instrument will return to sampling mode.

- `HE:TIME_limit?`

Returns the continuous measurement time limit in minutes.

- `LOG_LHE {0|1}`

Enables (1) or disables (0) liquid helium level logging.

- `LOG_LHE?`

Returns "0" if the liquid helium level logging is disabled, or "1" if enabled.

- `HELIUM_PowerSupply?`

Returns the helium power supply configuration of the instrument where “0” is not installed, “1” is standard, and “2” is XL version.

- `DIRTY_sen_mode?`

Returns a “0” if the instrument’s dirty sensor mode is disabled for the helium channel and a “1” if it is enabled.

ASSIGNMENT COMMANDS AND QUERIES

- `CONFigure:SOURCE:REC_out {0|1|2}`

Configures the 0-10 V_{DC} Recorder Output source to disabled (0), assigned to the nitrogen channel (1), or the helium channel (2).

- `SOURCE:REC_out?`

Returns a “0” if the 0-10 V_{DC} Recorder Output is disabled, a “1” if it is configured for the nitrogen channel, and a “2” if it is configured for the helium channel.

- `CONFigure:SOURCE:CURrent_LOOP {0|1|2}`

Configures the 4-20 mA Current Loop output source to disabled (0), assigned to the nitrogen channel (1), or the helium channel (2).

- `SOURCE:CURrent_LOOP?`

Returns a “0” if the 4-20 mA Current Loop output is disabled, a “1” if it is configured for the nitrogen channel, and a “2” if it is configured for the helium channel.

N2 CHANNEL CALIBRATION COMMANDS AND QUERIES

- `CONFigure:N2:LENgth <value>`

Configures the liquid nitrogen sensor active length in current units. Returns an error code if the current units are percent.

- `N2:LENgth?`

Returns the configured active length of the liquid nitrogen sensor in current units. Returns an error code if the current units are percent.

- `MINCAL`

Performs a minimum calibration point calibration.

- MAXCAL

Performs a maximum calibration point calibration.

- NOSENSORCAL

Calibrates the loss of sensor condition for the nitrogen measurement function.

HE CHANNEL CALIBRATION COMMANDS AND QUERIES

- CONFIGure:HE:LENGth <value>

Configures the liquid helium sensor active length in current units. Returns an error if the current units are percent.

- HE:LENGth?

Returns the configured active length of the liquid helium sensor in current units. Returns an error code if the current units are percent.

REMOTE UNITS COMMANDS AND QUERIES

- CONFIGure:N2:UNIT {0|1|2} or {PERCENT|CM|INCH}

Sets the liquid nitrogen level units of measurement to percent (0 or PERCENT), centimeters (1 or CM), or inches (2 or INCH). The default is PERCENT units.

- N2:UNIT?

Returns the current liquid helium level units in use as either C, I, or %.

- CONFIGure:HE:UNIT {0|1|2} or {PERCENT|CM|INCH}

Sets the liquid helium level units of measurement to percent (0 or PERCENT), centimeters (1 or CM), or inches (2 or INCH). The default is PERCENT units.

- HE:UNIT?

Returns the current liquid helium level units in use as either C, I, or %.

ERROR CODES

The Model 1700 returns specific error codes for invalid commands and/or arguments. If an error condition is returned, the command is not processed and the configuration of the instrument is not modified. The table below provides a list of error codes, their meaning, and any associated limits.

Error Code	Meaning	Valid Range
-1	LO (or relay №2 ^a) setpoint out of range	$0 \leq \text{LO (or relay №2}^{\text{a}}) \leq \text{LENGTH}$
-2	Fill B setpoint (fill start) out of range	$0 \leq B < A$
-3	Fill A setpoint (fill stop) out of range	$B < A \leq \text{LENGTH}$
-4	HI (or relay №1 ^a) setpoint out of range	$0 \leq \text{HI (or relay №1}^{\text{a}}) \leq \text{LENGTH}$
-5	Attempted to set or query for LENGTH in PERCENT units mode	
-6	Invalid argument, value out of maximum calibration range	$1 \text{ cm} \leq \text{value} \leq 650 \text{ cm (LN2)}$ $0 < \text{value} \leq 213.36 \text{ cm (HE)}$
-7	INTERVAL setting out of range	$0 \leq \text{INTERVAL} \leq 600 \text{ min}$
-8	Unrecognized command	
-9	Invalid argument, value was negative or non-numeric	
-10	Approximate calibration <i>factor</i> out of range	$0.1 \leq \text{factor} \leq 999.9$
-11	Command exceeds SCPI input buffer limit	256 characters, including spaces, etc.

a. Applies to dual instrument configuration

SERVICE AND REPAIR

CLEANING

To prevent electrical shock, disconnect the instrument from AC mains power and disconnect all connected wiring before cleaning. Clean the outside of the instrument using a soft, lint-free, cloth slightly dampened with water.

Do not use detergent or solvents.

Do not attempt internal cleaning.

USER REPLACEABLE PARTS

Replacement parts for the instrument are listed in the table below.

AMI Part Number	Description
HG0128	Instrument foot
SA 1045	Single Rack Mount Kit
SA 1046	Dual Rack Mount Kit
EF1700	Fuse, 3 A, 250 Vac, 5x20 mm, fast acting, UL/CSA recognized.
HG0005	Battery, 3V lithium, 20mm x 3.2 mm coin cell; CR2032.

BATTERY REPLACEMENT

This section describes the procedure for replacing the battery on the instrument's main circuit board.

WARNING This procedure should only be performed by a technician who is familiar with electronic instrumentation and trained in electrical safety and ESD precautions. Always disconnect the power cord and any external wiring before removing the instrument cover.

Always disconnect all inputs, cords, and cables before disassembling the instrument.

TOOLS REQUIRED

- Torx Plus (T.M.) size 10 driver (Wera 028034 or equivalent)
- Torx Plus (T.M.) size 15 driver (Wera 028035 or equivalent)
- Small, flat-blade screw driver (for prying)

PROCEDURE

1. Unplug the instrument from the AC power source.
2. Using the T-15 driver, remove the four 8-32 machine screws on the sides of the instrument cover. Set these screws aside as they will be re-used.
3. Using the T-10 driver, remove the four 6-32 machine screws on the rear of the instrument cover. Set these screws aside as they will be re-used.
4. Lift the instrument cover off of the instrument chassis and set aside.
5. Using the small, flat-blade screwdriver, carefully pry the battery from the holder BH1.
6. Install the new battery into the battery holder BH1.
7. Replace the top cover and secure using the eight machine screws which were removed previously.

FUSE REPLACEMENT

This section describes the procedure for replacing the two fuses on the instrument's main circuit board.

WARNING This procedure should only be performed by a technician who is familiar with electronic instrumentation and trained in electrical safety and ESD precautions. Always disconnect the power cord and any external wiring before removing the instrument cover.

Always disconnect all inputs, cords, and cables before disassembling the instrument.

TOOLS REQUIRED

- Torx Plus (T.M.) size 10 driver (Wera 028034 or equivalent)
- Torx Plus (T.M.) size 15 driver (Wera 028035 or equivalent)
- Small, flat-blade screw driver (for prying)

PROCEDURE

1. Unplug the instrument from the AC power source.
2. Using the T-15 driver, remove the four 8-32 machine screws on the sides of the instrument cover. Set these screws aside as they will be re-used.
3. Using the T-10 driver, remove the four 6-32 machine screws on the rear of the instrument cover. Set these screws aside as they will be re-used.
4. Lift the instrument cover off of the instrument chassis and set aside.
5. Using the small, flat-blade screwdriver, carefully pry the fuse(s) from the fuse holders F1 and/or F2.
6. Install the new fuse(s) into the fuse holder(s) F1 and/or F2.
7. Replace the top cover and secure using the eight machine screws which were removed previously.

FIRMWARE UPGRADE VIA MICRO-SD CARD REPLACEMENT

This section describes the procedure for replacing the Micro SD memory card on the instrument's Single Board Computer (SBC).

WARNING This procedure should only be performed by a technician who is familiar with electronic instrumentation and trained in electrical safety and ESD precautions. Always disconnect the power cord and any external wiring before removing the instrument cover.

Always disconnect all inputs, cords, and cables before disassembling the instrument.

TOOLS REQUIRED

- Torx Plus (T.M.) size 10 driver (Wera 028034 or equivalent)
- Torx Plus (T.M.) size 15 driver (Wera 028035 or equivalent)

PROCEDURE

1. Unplug the instrument from the AC power source.
2. Using the T-15 driver, remove the four 8-32 machine screws on the sides of the instrument cover. Set these screws aside as they will be re-used.
3. Using the T-10 driver, remove the four 6-32 machine screws on the rear of the instrument cover. Set these screws aside as they will be re-used.
4. Lift the instrument cover off of the instrument chassis and set aside.

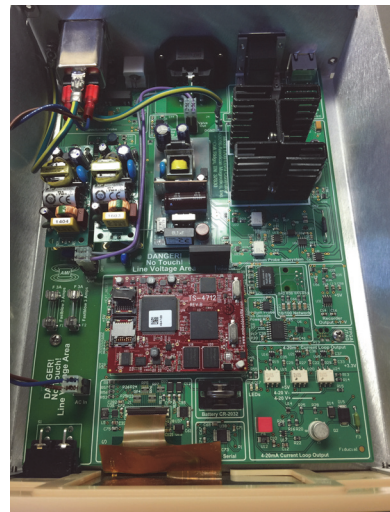

**Instrument With Cover
Removed**

5. Locate the Micro SD memory card on the SBC.

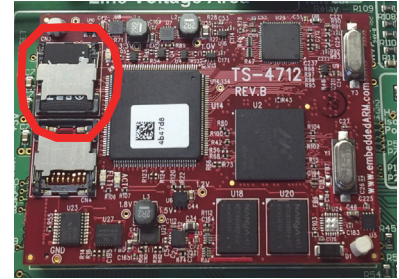

Instrument With Cover Removed

6. Using your thumbnail, press the metal cover that holds the memory card in place to the rear (Unlock).
7. Remove the memory card.
8. Insert the new memory card in the same orientation as the one just removed.
9. Carefully press the metal cover down and slide the cover toward the front of the instrument (Lock).
10. Reinstall the instrument cover.
11. Plug the instrument into the AC power source.
12. Energize the instrument via the front panel power switch.

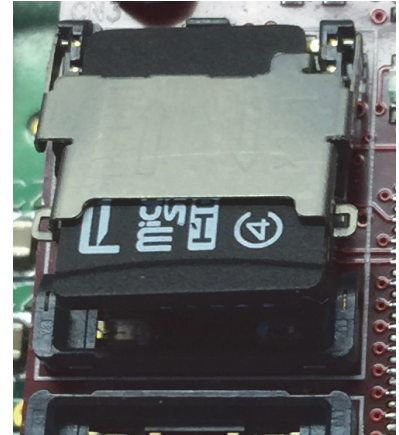

Memory Card Released

The instrument will boot from the new memory card. A re-calibration of the sensor(s) may be necessary.

Note that the firmware version can be determined by looking at the MENU > SYSTEM screen and the FW: field shows the current firmware version.

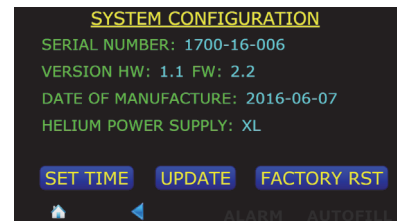

System Firmware Version

APPENDIX

SERIAL (RS-232) CONNECTOR

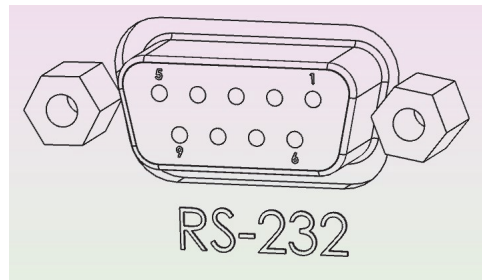

Serial (RS-232) Pin Out

The RS-232 connector is a 9-pin D-sub female connector to connect standard DTE 9-pin D-sub male connector using a standard straight (not NULL) cable.

Serial (RS-232) Pin Definitions

Pin	Mnemonic	Function
1	N/C	
2	TXD	Transmit Data
3	RXD	Receive Data
4	N/C	
5	GND	Signal Ground
6	N/C	
7	CTS	Clear to Send
8	RTS	Request to Send
9	N/C	

ETHERNET CONNECTOR

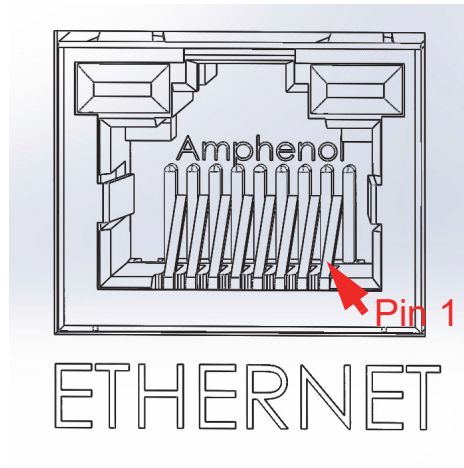

Ethernet Connector Socket Pin out

Ethernet RJ-45 Connector Pin Definitions

Pin	Mnemonic	Function
1	TXD+	Transmit differential output +
2	TXD-	Transmit differential output -
3	RXD+	Transmit differential input +
4	not used	
5		
6	RXD	Transmit differential input -
7	not used	
8		

LIQUID HELIUM CONNECTOR J1 WIRING

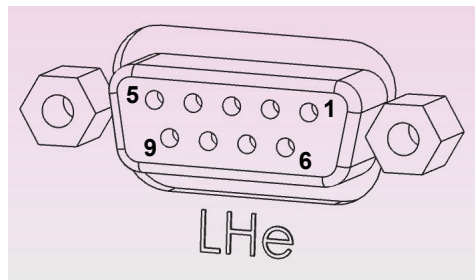

Liquid Helium (LHe) Level Sensor Connector

The LHe connector is a 9-pin D-sub female connector.

LHe Level Connector Pin Definitions

Pin	Function	AMI Standard Wiring Color
1	Sensor I+	Red
2	Not used	
3		
4		
5		
6	Sensor V-	Yellow
7	Sensor I-	Black
8	Sensor V+	Blue
9	Not used	

AUX I/O CONNECTOR



Aux I/O Connector

The AUX I/O connector is a 9-pin D-sub female connector.

Aux I/O Pin Definitions

Pin	Function	Polarity
1	4-20 mA Current Loop	+
2		-
3	0-10 VDC Output	+
4		-
5	Relay № 1 Dry Contact	N/A
6		
7	Relay № 2 Dry Contact	N/A
8		
9	N/A	

NOTE If the Model 1700 is being used to replace a Model 13x instrument, a M-M 9-pin gender changer will be necessary to change the female AUX I/O connector on the Model 1700 to a male type.

DIELECTRIC CONSTANTS FOR CRYOGENIC LIQUIDS

Common Cryogenic Liquid Dielectric Constants^a

Liquid	Dielectric Constant
Argon (Ar)	1.5034
Carbon Dioxide (CO ₂)	2.5911
Hydrogen (H ₂)	1.2307
Methane (CH ₄)	1.6257
Nitrogen (N ₂)	1.4327
Propane (C ₃ H ₈)	1.8029
Oxygen (O ₂)	1.4872

a. NIST RefProp version 9.1

TROUBLESHOOTING

The following paragraphs serve as an aid to assist the user in troubleshooting a potential problem with the Model 1700 Instrument. If the user is not comfortable in troubleshooting the system, contact an AMI Technical Support.

If the cause of the problem cannot be located, contact an AMI Technical Support Representative at +1 (865) 482-1056 for assistance. The AMI technical support group may also be reached by internet e-mail at:

support@americanmagnetics.com

INSTRUMENT DISPLAYS “LOSS OF SENSOR” CONDITION FOR LN₂ LEVEL MEASUREMENT

This message indicates one of two things: the signal from the external oscillator/transmitter has been lost (disconnection) or the capacitance measured by the instrument is significantly less than the minimum capacitance expected during level measurement¹. Ensure the instrument has been calibrated (especially “Performing Loss of Sensor Calibration” on page 56) and is properly connected via coaxial cable(s) to the BNC connector on the back of the instrument.

INSTRUMENT DISPLAYS “LOSS OF SENSOR” CONDITION FOR LHe LEVEL MEASUREMENT

This message indicates that the instrument cannot get sensor excitation current to flow in the sensor circuit². Check that the sensor is wired correctly and that the sensor is connected to the proper connector on the back of the instrument. When the wiring is corrected, place the instrument in MEASURE CONTINUALLY mode and the Loss of Sensor condition should be cleared at which time the instrument can be placed back in SAMPLE & HOLD mode if desired.

INSTRUMENT DISPLAYS “SENSOR SHORTED” CONDITION FOR LN₂ LEVEL MEASUREMENT

This message indicates that the sensor oscillator circuit has ceased oscillating. This is usually caused by a contaminated level sensor where a conductive substance (usually water) is shorting out the sensor tubes.³ Dry or clean out the sensor and this condition is usually removed. Note

-
1. The threshold is the midpoint between the MINimum CALibration and the NO SENSOR CALibration.
 2. The threshold is approximately 1 mA.
 3. The threshold is approximately 200 kohms with a sensor capacitance of 2 nF.

that the sensor resistance measured across the BNC connector should be $>10^7$ ohms.¹

INSTRUMENT DISPLAYS “SENSOR PROTECTED” CONDITION FOR LHe MEASUREMENT

This message indicates that the LHe level sensor circuit is of a higher impedance than expected for the selected active sensor length.² The protection means that the normal sensor excitation has been stopped and the sensor is intermittently pulsing the current to see if the resistance is back in the expected range. This condition is usually seen when the instrument is set for an active length greater than the level sensor connected to the instrument. See “Sensor Active Length” on page 70. This condition will also occur if a LHe level sensor is energized in a vacuum since the level sensor’s sensing element will heat up to an abnormally high temperature and with its positive temperature coefficient, present a larger than expected resistance to the instrument.

-
1. Any resistance between the sensor elements will cause the instrument to read higher than actual level.
 2. The threshold is 5% greater resistance than the SENSOR ACTIVE LENGTH resistance.

FIRMWARE LICENSES

The Model 1700 firmware is based on a distribution of Debian Linux, with modifications to the Linux kernel by Technologic Systems and AMI, and additional user interface components by AMI. Some components of this firmware are licensed under agreements that require AMI to make source code available to interested parties. Other components require explicit acknowledgment of the authorship/ownership of the firmware and/or the terms under which it is licensed. In particular:

The Linux kernel version 2.6.34 is licensed under the GNU Public License, version 2. Source code for the version of the Linux kernel used in the Model 1700 is available from the Technologic Systems github repository at <https://github.com/embeddedarm/linux-2.6.34-ts471x.git>

AMI's modifications to that Linux kernel sources are available from: <http://firmware.americanmagnetics.com/1700/kernel-patches.tar>

The Model 1700 uses the "lighttpd" web server, available in source code form from <https://www.lighttpd.net>. It is made available under the following license:

```
Copyright (c) 2004, Jan Kneschke, incremental
All rights reserved.
```

```
Redistribution and use in source and binary forms, with or without
modification, are permitted provided that the following conditions are
met:
```

- Redistributions of source code must retain the above copyright notice, this list of conditions and the following disclaimer.
- Redistributions in binary form must reproduce the above copyright notice, this list of conditions and the following disclaimer in the documentation and/or other materials provided with the distribution.
- Neither the name of the 'incremental' nor the names of its contributors may be used to endorse or promote products derived from this software without specific prior written permission.

```
THIS SOFTWARE IS PROVIDED BY THE COPYRIGHT HOLDERS AND CONTRIBUTORS "AS
IS" AND ANY EXPRESS OR IMPLIED WARRANTIES, INCLUDING, BUT NOT LIMITED TO,
THE IMPLIED WARRANTIES OF MERCHANTABILITY AND FITNESS FOR A PARTICULAR
PURPOSE ARE DISCLAIMED. IN NO EVENT SHALL THE COPYRIGHT OWNER OR
CONTRIBUTORS BE LIABLE FOR ANY DIRECT, INDIRECT, INCIDENTAL, SPECIAL,
EXEMPLARY, OR CONSEQUENTIAL DAMAGES (INCLUDING, BUT NOT LIMITED TO,
PROCUREMENT OF SUBSTITUTE GOODS OR SERVICES; LOSS OF USE, DATA, OR
PROFITS; OR BUSINESS INTERRUPTION) HOWEVER CAUSED AND ON ANY THEORY OF
LIABILITY, WHETHER IN CONTRACT, STRICT LIABILITY, OR TORT (INCLUDING
NEGLIGENCE OR OTHERWISE) ARISING IN ANY WAY OUT OF THE USE OF THIS
SOFTWARE, EVEN IF ADVISED OF THE POSSIBILITY OF SUCH DAMAGE.
```

The Model 1700 firmware includes an OpenSSH client and server and also uses OpenSSH libraries in other components. The individual components of OpenSSH are subject to different licenses, all of which

permit free distribution of compiled versions of the software, though some require explicit notice. Those required notices are reproduced below:

NO WARRANTY

BECAUSE THE PROGRAM IS LICENSED FREE OF CHARGE, THERE IS NO WARRANTY FOR THE PROGRAM, TO THE EXTENT PERMITTED BY APPLICABLE LAW. EXCEPT WHEN OTHERWISE STATED IN WRITING THE COPYRIGHT HOLDERS AND/OR OTHER PARTIES PROVIDE THE PROGRAM "AS IS" WITHOUT WARRANTY OF ANY KIND, EITHER EXPRESSED OR IMPLIED, INCLUDING, BUT NOT LIMITED TO, THE IMPLIED WARRANTIES OF MERCHANTABILITY AND FITNESS FOR A PARTICULAR PURPOSE. THE ENTIRE RISK AS TO THE QUALITY AND PERFORMANCE OF THE PROGRAM IS WITH YOU. SHOULD THE PROGRAM PROVE DEFECTIVE, YOU ASSUME THE COST OF ALL NECESSARY SERVICING, REPAIR OR CORRECTION.

IN NO EVENT UNLESS REQUIRED BY APPLICABLE LAW OR AGREED TO IN WRITING WILL ANY COPYRIGHT HOLDER, OR ANY OTHER PARTY WHO MAY MODIFY AND/OR REDISTRIBUTE THE PROGRAM AS PERMITTED ABOVE, BE LIABLE TO YOU FOR DAMAGES, INCLUDING ANY GENERAL, SPECIAL, INCIDENTAL OR CONSEQUENTIAL DAMAGES ARISING OUT OF THE USE OR INABILITY TO USE THE PROGRAM (INCLUDING BUT NOT LIMITED TO LOSS OF DATA OR DATA BEING RENDERED INACCURATE OR LOSSES SUSTAINED BY YOU OR THIRD PARTIES OR A FAILURE OF THE PROGRAM TO OPERATE WITH ANY OTHER PROGRAMS), EVEN IF SUCH HOLDER OR OTHER PARTY HAS BEEN ADVISED OF THE POSSIBILITY OF SUCH DAMAGES.

The 32-bit CRC compensation attack detector in deattack.c was contributed by CORE SDI S.A. under a BSD-style license.

```
* Cryptographic attack detector for ssh - source code
*
* Copyright (c) 1998 CORE SDI S.A., Buenos Aires, Argentina.
*
* All rights reserved. Redistribution and use in source and binary
* forms, with or without modification, are permitted provided that
* this copyright notice is retained.
*
* THIS SOFTWARE IS PROVIDED ``AS IS'' AND ANY EXPRESS OR IMPLIED
* WARRANTIES ARE DISCLAIMED. IN NO EVENT SHALL CORE SDI S.A. BE
* LIABLE FOR ANY DIRECT, INDIRECT, INCIDENTAL, SPECIAL, EXEMPLARY OR
* CONSEQUENTIAL DAMAGES RESULTING FROM THE USE OR MISUSE OF THIS
* SOFTWARE.
*
* Ariel Futoransky <futo@core-sdi.com>
* <http://www.core-sdi.com>
```

ssh-keyscan was contributed by David Mazieres under a BSD-style license.

```
* Copyright 1995, 1996 by David Mazieres <dm@lcs.mit.edu>.
*
* Modification and redistribution in source and binary forms is
* permitted provided that due credit is given to the author and the
* OpenBSD project by leaving this copyright notice intact.
```

The Rijndael implementation by Vincent Rijmen, Antoon Bosselaers and Paulo Barreto is in the public domain and distributed with the following license:

```
* @version 3.0 (December 2000)
*
* Optimised ANSI C code for the Rijndael cipher (now AES)
*
* @author Vincent Rijmen <vincent.rijmen@esat.kuleuven.ac.be>
* @author Antoon Bosselaers <antoon.bosselaers@esat.kuleuven.ac.be>
* @author Paulo Barreto <paulo.barreto@terra.com.br>
```

```

*
* This code is hereby placed in the public domain.
*
* THIS SOFTWARE IS PROVIDED BY THE AUTHORS 'AS IS' AND ANY EXPRESS
* OR IMPLIED WARRANTIES, INCLUDING, BUT NOT LIMITED TO, THE IMPLIED
* WARRANTIES OF MERCHANTABILITY AND FITNESS FOR A PARTICULAR PURPOSE
* ARE DISCLAIMED. IN NO EVENT SHALL THE AUTHORS OR CONTRIBUTORS BE
* LIABLE FOR ANY DIRECT, INDIRECT, INCIDENTAL, SPECIAL, EXEMPLARY, OR
* CONSEQUENTIAL DAMAGES (INCLUDING, BUT NOT LIMITED TO, PROCUREMENT OF
* SUBSTITUTE GOODS OR SERVICES; LOSS OF USE, DATA, OR PROFITS; OR
* BUSINESS INTERRUPTION) HOWEVER CAUSED AND ON ANY THEORY OF LIABILITY,
* WHETHER IN CONTRACT, STRICT LIABILITY, OR TORT (INCLUDING NEGLIGENCE
* OR OTHERWISE) ARISING IN ANY WAY OUT OF THE USE OF THIS SOFTWARE,
* EVEN IF ADVISED OF THE POSSIBILITY OF SUCH DAMAGE.

```

One component of the ssh source code is under a 3-clause BSD license, held by the University of California, since we pulled these parts from original Berkeley code.

```

* Copyright (c) 1983, 1990, 1992, 1993, 1995
*   The Regents of the University of California. All rights reserved.
*
* Redistribution and use in source and binary forms, with or without
* modification, are permitted provided that the following conditions
* are met:
* 1. Redistributions of source code must retain the above copyright
*   notice, this list of conditions and the following disclaimer.
* 2. Redistributions in binary form must reproduce the above copyright
*   notice, this list of conditions and the following disclaimer in the
*   documentation and/or other materials provided with the distribution.
* 3. Neither the name of the University nor the names of its contributors
*   may be used to endorse or promote products derived from this software
*   without specific prior written permission.
*
* THIS SOFTWARE IS PROVIDED BY THE REGENTS AND CONTRIBUTORS 'AS IS' AND
* ANY EXPRESS OR IMPLIED WARRANTIES, INCLUDING, BUT NOT LIMITED TO, THE
* IMPLIED WARRANTIES OF MERCHANTABILITY AND FITNESS FOR A PARTICULAR PURPOSE
* ARE DISCLAIMED. IN NO EVENT SHALL THE REGENTS OR CONTRIBUTORS BE LIABLE
* FOR ANY DIRECT, INDIRECT, INCIDENTAL, SPECIAL, EXEMPLARY, OR CONSEQUENTIAL
* DAMAGES (INCLUDING, BUT NOT LIMITED TO, PROCUREMENT OF SUBSTITUTE GOODS
* OR SERVICES; LOSS OF USE, DATA, OR PROFITS; OR BUSINESS INTERRUPTION)
* HOWEVER CAUSED AND ON ANY THEORY OF LIABILITY, WHETHER IN CONTRACT, STRICT
* LIABILITY, OR TORT (INCLUDING NEGLIGENCE OR OTHERWISE) ARISING IN ANY WAY
* OUT OF THE USE OF THIS SOFTWARE, EVEN IF ADVISED OF THE POSSIBILITY OF
* SUCH DAMAGE.

```

Remaining components of the software are provided under a standard 2-term BSD license with the following names as copyright holders:

```

Markus Friedl
Theo de Raadt
Niels Provos
Dug Song
Aaron Campbell
Damien Miller
Kevin Steves
Daniel Kouril
Wesley Griffin
Per Allansson
Nils Nordman
Simon Wilkinson

```

Portable OpenSSH additionally includes code from the following copyright holders, also under the 2-term BSD license:

```

Ben Lindstrom
Tim Rice
Andre Lucas

```

Chris Adams
 Corinna Vinschen
 Cray Inc.
 Denis Parker
 Gert Doering
 Jakob Schlyter
 Jason Downs
 Juha Yrj?l
 Michael Stone
 Networks Associates Technology, Inc.
 Solar Designer
 Todd C. Miller
 Wayne Schroeder
 William Jones
 Darren Tucker
 Sun Microsystems
 The SCO Group
 Daniel Walsh
 Red Hat, Inc
 Simon Vallet / Genoscope

* Redistribution and use in source and binary forms, with or without
 * modification, are permitted provided that the following conditions
 * are met:
 * 1. Redistributions of source code must retain the above copyright
 * notice, this list of conditions and the following disclaimer.
 * 2. Redistributions in binary form must reproduce the above copyright
 * notice, this list of conditions and the following disclaimer in the
 * documentation and/or other materials provided with the distribution.
 *

* THIS SOFTWARE IS PROVIDED BY THE AUTHOR ``AS IS'' AND ANY EXPRESS OR
 * IMPLIED WARRANTIES, INCLUDING, BUT NOT LIMITED TO, THE IMPLIED WARRANTIES
 * OF MERCHANTABILITY AND FITNESS FOR A PARTICULAR PURPOSE ARE DISCLAIMED.
 * IN NO EVENT SHALL THE AUTHOR BE LIABLE FOR ANY DIRECT, INDIRECT,
 * INCIDENTAL, SPECIAL, EXEMPLARY, OR CONSEQUENTIAL DAMAGES (INCLUDING, BUT
 * NOT LIMITED TO, PROCUREMENT OF SUBSTITUTE GOODS OR SERVICES; LOSS OF USE,
 * DATA, OR PROFITS; OR BUSINESS INTERRUPTION) HOWEVER CAUSED AND ON ANY
 * THEORY OF LIABILITY, WHETHER IN CONTRACT, STRICT LIABILITY, OR TORT
 * (INCLUDING NEGLIGENCE OR OTHERWISE) ARISING IN ANY WAY OUT OF THE USE OF
 * THIS SOFTWARE, EVEN IF ADVISED OF THE POSSIBILITY OF SUCH DAMAGE.

Portable OpenSSH contains the following additional licenses:

a) md5crypt.c, md5crypt.h
 * "THE BEER-WARE LICENSE" (Revision 42):
 * <phk@login.dknet.dk> wrote this file. As long as you retain this
 * notice you can do whatever you want with this stuff. If we meet
 * some day, and you think this stuff is worth it, you can buy me a
 * beer in return. Poul-Henning Kamp
 b) snprintf replacement
 * Copyright Patrick Powell 1995
 * This code is based on code written by Patrick Powell
 * (papowell@astart.com) It may be used for any purpose as long as this
 * notice remains intact on all source code distributions
 c) Compatibility code (openbsd-compat)
 Apart from the previously mentioned licenses, various pieces of
 code
 in the openbsd-compat/ subdirectory are licensed as follows:
 Some code is licensed under a 3-term BSD license, to the following
 copyright holders:
 Todd C. Miller
 Theo de Raadt
 Damien Miller
 Eric P. Allman
 The Regents of the University of California
 Constantin S. Svintsoff
 * Redistribution and use in source and binary forms, with or without

```
* modification, are permitted provided that the following conditions
* are met:
* 1. Redistributions of source code must retain the above copyright
* notice, this list of conditions and the following disclaimer.
* 2. Redistributions in binary form must reproduce the above copyright
* notice, this list of conditions and the following disclaimer in the
* documentation and/or other materials provided with the distribution.
* 3. Neither the name of the University nor the names of its contributors
* may be used to endorse or promote products derived from this software
* without specific prior written permission.
*
```

```
* THIS SOFTWARE IS PROVIDED BY THE REGENTS AND CONTRIBUTORS ``AS IS'' AND
* ANY EXPRESS OR IMPLIED WARRANTIES, INCLUDING, BUT NOT LIMITED TO, THE
* IMPLIED WARRANTIES OF MERCHANTABILITY AND FITNESS FOR A PARTICULAR PURPOSE
* ARE DISCLAIMED. IN NO EVENT SHALL THE REGENTS OR CONTRIBUTORS BE LIABLE
* FOR ANY DIRECT, INDIRECT, INCIDENTAL, SPECIAL, EXEMPLARY, OR CONSEQUENTIAL
* DAMAGES (INCLUDING, BUT NOT LIMITED TO, PROCUREMENT OF SUBSTITUTE GOODS
* OR SERVICES; LOSS OF USE, DATA, OR PROFITS; OR BUSINESS INTERRUPTION)
* HOWEVER CAUSED AND ON ANY THEORY OF LIABILITY, WHETHER IN CONTRACT, STRICT
* LIABILITY, OR TORT (INCLUDING NEGLIGENCE OR OTHERWISE) ARISING IN ANY WAY
* OUT OF THE USE OF THIS SOFTWARE, EVEN IF ADVISED OF THE POSSIBILITY OF
* SUCH DAMAGE.
```

Some code is licensed under an ISC-style license, to the following copyright holders:

Internet Software Consortium.
 Todd C. Miller
 Reyk Floeter
 Chad Mynhier

```
* Permission to use, copy, modify, and distribute this software for any
* purpose with or without fee is hereby granted, provided that the above
* copyright notice and this permission notice appear in all copies.
*
```

```
* THE SOFTWARE IS PROVIDED "AS IS" AND TODD C. MILLER DISCLAIMS ALL
* WARRANTIES WITH REGARD TO THIS SOFTWARE INCLUDING ALL IMPLIED WARRANTIES
* OF MERCHANTABILITY AND FITNESS. IN NO EVENT SHALL TODD C. MILLER BE LIABLE
* FOR ANY SPECIAL, DIRECT, INDIRECT, OR CONSEQUENTIAL DAMAGES OR ANY DAMAGES
* WHATSOEVER RESULTING FROM LOSS OF USE, DATA OR PROFITS, WHETHER IN AN ACTION
* OF CONTRACT, NEGLIGENCE OR OTHER TORTIOUS ACTION, ARISING OUT OF OR IN
* CONNECTION WITH THE USE OR PERFORMANCE OF THIS SOFTWARE.
```

Some code is licensed under a MIT-style license to the following copyright holders:

Free Software Foundation, Inc.

```
* Permission is hereby granted, free of charge, to any person obtaining a
* copy of this software and associated documentation files (the
* "Software"), to deal in the Software without restriction, including
* without limitation the rights to use, copy, modify, merge, publish,
* distribute, distribute with modifications, sublicense, and/or sell
* copies of the Software, and to permit persons to whom the Software is
* furnished to do so, subject to the following conditions:
*
```

```
* The above copyright notice and this permission notice shall be included
* in all copies or substantial portions of the Software.
*
```

```
* THE SOFTWARE IS PROVIDED "AS IS", WITHOUT WARRANTY OF ANY KIND, EXPRESS
* OR IMPLIED, INCLUDING BUT NOT LIMITED TO THE WARRANTIES OF
* MERCHANTABILITY, FITNESS FOR A PARTICULAR PURPOSE AND NONINFRINGEMENT.
* IN NO EVENT SHALL THE ABOVE COPYRIGHT HOLDERS BE LIABLE FOR ANY CLAIM,
* DAMAGES OR OTHER LIABILITY, WHETHER IN AN ACTION OF CONTRACT, TORT OR
* OTHERWISE, ARISING FROM, OUT OF OR IN CONNECTION WITH THE SOFTWARE OR
* THE USE OR OTHER DEALINGS IN THE SOFTWARE.
*
```

```
* Except as contained in this notice, the name(s) of the above copyright
* holders shall not be used in advertising or otherwise to promote the
* sale, use or other dealings in this Software without prior written
* authorization.
*
```

*****/

The Model 1700 firmware uses portions of the "tslib" touchscreen library, which are licensed under the GNU Public License, version 2.

The source code to tslib was obtained by AMI from github.com using the command: `git clone https://github.com/kergoth/tslib`

The Model 1700's touchscreen browser was linked against the Qt libraries for The X Window System that were available from the Debian package repository. The source code for those libraries, as well as the compilers and other tools required to recompile those libraries and the browser, are available from the Debian repository using the normal Debian package manipulation commands, e.g. `pkg-add` or `symantic`. The source code for the browser is brief enough to be included here:

```
---begin file browser.cpp---
#include <QtGui>
#include <QtWebKit>
int main(int argc, char** argv) {
    QApplication app(argc, argv);
    QWebView view;
    view.setWindowFlags (Qt::FramelessWindowHint);
    view.showFullScreen ();
    view.setUrl(QUrl(argv[1]));
    return app.exec();
}
---end file browser.cpp---
---begin file browser.pro---
QT += webkit
SOURCES = browser.cpp
---end file browser.pro---
```

The Model 1700 firmware uses the Jansson library for encoding and decoding messages in the JSON (JavaScript Object Notation) format. The Jansson library is subject to the following license:

Permission is hereby granted, free of charge, to any person obtaining a copy of this software and associated documentation files (the "Software"), to deal in the Software without restriction, including without limitation the rights to use, copy, modify, merge, publish, distribute, sublicense, and/or sell copies of the Software, and to permit persons to whom the Software is furnished to do so, subject to the following conditions:

The above copyright notice and this permission notice shall be included in all copies or substantial portions of the Software.

THE SOFTWARE IS PROVIDED "AS IS", WITHOUT WARRANTY OF ANY KIND, EXPRESS OR IMPLIED, INCLUDING BUT NOT LIMITED TO THE WARRANTIES OF MERCHANTABILITY, FITNESS FOR A PARTICULAR PURPOSE AND NONINFRINGEMENT. IN NO EVENT SHALL THE AUTHORS OR COPYRIGHT HOLDERS BE LIABLE FOR ANY CLAIM, DAMAGES OR OTHER LIABILITY, WHETHER IN AN ACTION OF CONTRACT, TORT OR OTHERWISE, ARISING FROM, OUT OF OR IN CONNECTION WITH THE SOFTWARE OR THE USE OR OTHER DEALINGS IN THE SOFTWARE.

The "home" icon was obtained from https://www.iconfinder.com/icons/40798/home_icon#size=128

The license terms stated on that page are: Free for commercial use (Do not redistribute)

The "back" icon was obtained from: https://www.iconfinder.com/icons/27865/play_right_arrow_icon#size=128

The license terms stated on that page are: Creative Commons Attribution-No Derivative Works 3.0 Unported

The X.org display server is licensed under the following conditions:

Permission is hereby granted, free of charge, to any person obtaining a copy of this software and associated documentation files (the "Software"), to deal in the Software without restriction, including without limitation the rights to use, copy, modify, merge, publish, distribute, sublicense, and/or sell copies of the Software, and to permit persons to whom the Software is furnished to do so, subject to the following conditions:

The above copyright notice and this permission notice shall be included in all copies or substantial portions of the Software.

THE SOFTWARE IS PROVIDED "AS IS", WITHOUT WARRANTY OF ANY KIND, EXPRESS OR IMPLIED, INCLUDING BUT NOT LIMITED TO THE WARRANTIES OF MERCHANTABILITY, FITNESS FOR A PARTICULAR PURPOSE AND NONINFRINGEMENT. IN NO EVENT SHALL THE AUTHORS OR COPYRIGHT HOLDERS BE LIABLE FOR ANY CLAIM, DAMAGES OR OTHER LIABILITY, WHETHER IN AN ACTION OF CONTRACT, TORT OR OTHERWISE, ARISING FROM, OUT OF OR IN CONNECTION WITH THE SOFTWARE OR THE USE OR OTHER DEALINGS IN THE SOFTWARE.

ASCO SOLENOID-OPERATED FLOW VALVE DATA SHEET

I&M No. V 6584 R19 sec1

Installation & Maintenance Instructions  OPEN-FRAME, GENERAL PURPOSE, WATERTIGHT/EXPLOSIONPROOF SOLENOIDS OPTIONAL FEATURE FOR OPEN FRAME (GENERAL PURPOSE) CONSTRUCTION ONLY	SERIES 8003G/H 8007G/H 8202G/H
--	--

— SERVICE NOTICE —

ASCO® solenoid valves with design change letter “G” or “H” in the catalog number (ex. 8210G1) have an epoxy encapsulated ASCO™ Red Hat II™ solenoid. This solenoid replaces some of the solenoids with metal enclosures and open-frame constructions. Follow these installation and maintenance instructions if your valve or operator uses this solenoid.

See separate instructions for basic valve.

DESCRIPTION

Catalog numbers 8003G/H, 8007G/H and 8202G/H and are epoxy encapsulated pull-type solenoids. The green solenoid with lead wires and 1/2 conduit connection is designed to meet Enclosure Type 1-General Purpose, Type 2-Dripproof, Types 3 and 3S-Raintight, and Types 4 and 4X-Watertight. The black solenoid on catalog numbers prefixed “EF” or “EV” is designed to meet Enclosure Types 3 and 3S-Raintight, Types 4 and 4X-Watertight, Types 6 and 6P-Submersible, Type 7, Explosionproof Class I, Division1 Groups A, B, C, & D and Type 9, -Dust-Ignitionproof Class II, Division1 Groups E, F & G. The Class II, Groups F & G Dust Locations designation is not applicable for solenoids or solenoid valves used for steam service or when a class “H” solenoid is used. See *Temperature Limitations* section for solenoid identification and nameplate/retainer for service. When installed just as a solenoid and not attached to an ASCO valve, the core has a 0.250-28 UNF-2B tapped hole, 0.38 or 0.63 minimum full thread.

NOTE: Catalog number prefix “EV” denotes stainless steel construction.

Solenoid catalog numbers 8202G/H1, 8202G/H3, 8202G/H5 and 8202G/H7 are epoxy encapsulated push-type, reverse-acting solenoids having the same enclosure types as previously stated for Catalog numbers 8003G/H1 and 8003G/H2. 8007G/H are 3-way solenoid operators with a pipe port or adapter, exhaust protector or vent at the top of the solenoid base sub-assembly.

Series 8003G/H, 8007G/H and 8202G/H solenoids are also available in:

- **Open-Frame Construction:** The green solenoid may be supplied with 1/4” spade, screw or DIN terminals. (Refer to Figure 4)
 - **DIN Plug Connector Kit No. K236034:** Use this kit only for solenoids with DIN terminals. The DIN plug connector kit provides a two pole with grounding contact DIN Type 43650 construction (See Figure 6).
- **Panel Mounted Construction:** These solenoids are specifically designed to be panel mounted by the customer. Refer to Figures specified in this I&M and the section on *Installation of Panel Mounted Solenoid* for details.
- **Junction Box:** This junction box construction meets Enclosure Types 2, 3, 3S, 4, and 4X. Only solenoids with 1/4” spade or screw terminals may have a junction box. The junction box provides a 1/2” conduit connection, grounding and spade or screw terminal connections within the junction box (See Figure 5).
- **Multipin Connectors:** All Multipin connectors (VT, VB, ZT, ZB) do not have any enclosure ratings.

NOTE: For China RoHS Hazardous Substances table, please go to the link below or scan QR code:
www.ascov.com/ChinaRoHSDisclosure



OPERATION

Series 8003G/H and 8007G/H - When the solenoid is energized, the core is drawn into the solenoid base sub-assembly.

IMPORTANT: When the solenoid is de-energized, the initial return force for the core, whether developed by spring, pressure, or weight, must exert a minimum force to overcome residual magnetism created by the solenoid. Minimum return force for AC construction is 11 ounces, and 5 ounces for DC construction.

Series 8202G/H - When the solenoid is energized, the disc holder assembly seats against the orifice. When the solenoid is de-energized, the disc holder assembly returns. **IMPORTANT:** Initial return force for the disc or disc holder assembly, whether developed by spring, pressure, or weight, must exert a minimum force to overcome residual magnetism created by the solenoid. Minimum return force is 1 pound, 5 ounces.

INSTALLATION

Check nameplate for correct catalog number, service, and wattage. Check front of solenoid for voltage and frequency.

▲ WARNING: Electrical hazard from the accessibility of live parts. To prevent the possibility of death, serious injury or property damage, install the open - frame solenoid in an enclosure.

▲ AVERTISSEMENT: Risque d'accès aux parties électriques actives. Afin d'éviter tout risque de mort, blessure ou dommage, installer la bobine dans un boîtier.

FOR BLACK ENCLOSURE TYPES 7 AND 9 ONLY

▲ CAUTION: To prevent fire or explosion, do not install solenoid and/or valve where ignition temperature of hazardous atmosphere is less than 165°C. On valves used for steam service or when a class “H” solenoid is used, do not install in hazardous atmosphere where ignition temperature is less than 180°C. See nameplate/retainer for service.

▲ ATTENTION : Afin d'éviter le risque de feu ou d'explosion, ne pas installer la bobine ou l'électrovanne où la température d'inflammation en atmosphère explosible est inférieure à 165°C. Pour les vannes vapeur où lorsqu'une bobine de classe H est utilisée, ne pas installer en atmosphère explosible lorsque la température d'inflammation est inférieure à 180°C. Consulter les conditions d'utilisations sûres indiquées sur le produit ou dans la notice.

NOTE: These solenoids have an internal non-resettable thermal fuse to limit solenoid temperature in the event that extraordinary conditions occur which could cause excessive temperatures. These conditions include high input voltage, a jammed core, excessive ambient temperature or a shorted solenoid, etc. This unique feature is a standard feature only in solenoids with black explosionproof/dust-ignitionproof enclosures (Types 7 & 9).

ASCO Valves® E265662 - 06/2016 All Rights Reserved.

I&M No. V 6584 R19 sec1

©ASCO Valve, Inc. 50 Hanover Road, Florham Park, New Jersey 07932

www.ascov.com

Page 1 of 6

▲ CAUTION: To protect the solenoid valve or operator, install a strainer or filter, suitable for the service involved in the inlet side as close to the valve or operator as possible. Clean periodically depending on service conditions. See ASCO Series 8600 and 8601 for strainers.

▲ ATTENTION : Afin de protéger l'électrovanne ou l'actionneur, installer une crépine ou un filtre adapté le plus proche possible en amont de l'électrovanne ou de l'actionneur. Nettoyer périodiquement le filtre en fonction des conditions d'utilisation. Se référer aux séries 8600 et 8601 pour les crépines.

Temperature Limitations

For maximum solenoid ambient temperatures, refer to chart. The temperature limitations listed, only indicate maximum application temperatures for field wiring rated at 90°C. Check catalog number prefix and watt rating on nameplate to determine maximum ambient temperature. See valve installation and maintenance instructions for maximum ambient and fluid temperatures.

NOTE: For steam service, refer to *Wiring* section, *Junction Box* for temperature rating of supply wires.

Temperature Limitations For Series 8003G, 8007G or 8202G			
Watt Rating	Catalog Number Coil Prefix	Class of Insulation	Maximum § Ambient Temp.
10.1 & 17.1	None, FB, KF, KP, SC, SD, SF, SP, VT, VB, ZT & ZB	F	125°F (52°C)
10.1, 17.1 & 24.6	HB, HT, KB, KH, SS, ST, SU, HC	H	140°F (60°C)
11.6 & 22.6	None, FB, KF, KP, SC, SD, SF, SP, VT, VB, ZT & ZB	F	104°F (40°C)
11.6 & 22.6	HP, HT, KB, KH, SS, ST, SU & SV	H	104°F (40°C)
15.6	None, KB, SS, SV	H	104°F (40°C)

§ Minimum ambient temperature -40°F (-40°C).

Temperature Limitations for Series 8003H, 8007H and 8202H solenoids						
Prefix ¹	Coil Class	Watt Ratings			Maximum Ambient Temperature	
		AC		DC	°C	°F
		60 Hz	50 Hz			
EF, EV	FT	10.1	10.1	-	52	125
EF, EV	FB	17.1	17.1	-		
	FT	10.1	10.1	-		
	FB	17.1	17.1	-	55	131
	HT	-	-	11.6		
	HF	-	-	15.6		
	HB	-	-	22.6	40 ²	104 ²
EF, EV	HT	-	-	11.6		
EF, EV	HF	-	-	15.6		
EF, EV	HB	-	-	22.6		
	HT	10.1	10.1	-		
	HB	17.1	17.1	-		
EF, EV	HT	10.1	10.1	-	60 ³	140 ³
EF, EV	HB	17.1	17.1	-		
EF, EV	HC	-	-	24.6		

¹ = EF, EV data applies to Explosionproof coils only.
² = Some DC solenoid valves can be operated at maximum ambient temperature of 55°C / 131°F with reduced pressure ratings. See valve I&M for maximum operating pressure differential ratings.
³ = Steam Service Valves have a maximum ambient temperature of 55°C / 131°F.

Positioning

This solenoid is designed to perform properly when mounted in any position. However, for optimum life and performance, the solenoid should be mounted vertically and upright to reduce the possibility of foreign matter accumulating in the solenoid base sub-assembly area.

Wiring

Wiring must comply with local codes and the National Electrical Code. All solenoids supplied with lead wires are provided with a grounding wire which is green or green with yellow stripes and a 1/2" conduit connection. To facilitate wiring, the solenoid may be rotated 360°. For explosionproof solenoid version, the conduit lead wires are factory sealed for use in hazardous locations.

▲ CAUTION: Cryogenic Applications - Solenoid lead wire insulation should not be subjected to cryogenic temperatures. Adequate lead wire protection and routing must be provided.

▲ ATTENTION: Application cryogénique. Les câbles électriques ne doivent pas être soumis à des températures cryogéniques. Une protection adéquate des câbles électriques doit être fournie.

Additional Wiring Instructions For Optional Features:

- **Open-Frame solenoid with 1/4" spade terminals.**

For solenoids supplied with screw terminal connections use #12-18 AWG stranded copper wire rated at 90°C or greater. Torque terminal block screws to 10±2 in-lbs [1,0±1,2 Nm]. A tapped hole is provided in the solenoid for grounding, use a #10-32 machine screw. Torque grounding screw to 15-20 in-lbs [1,7-2,3 Nm]. On solenoids with screw terminals, the socket head screw holding the terminal block to the solenoid is the grounding screw. Torque the screw to 15-20 in-lbs [1,7-2,3 Nm] with a 5/32" hex key wrench.

- **Junction Box**

The junction box is used with spade or screw terminal solenoids only and is provided with a grounding screw and a 1/2" conduit connection. Connect #12-18 AWG standard copper wire only to the screw terminals. Within the junction box use field wire that is rated 90°C or greater for connections. For steam service use 105°C rated wire up to 50 psi or use 125°C rated wire above 50 psi. After electrical hookup, replace cover gasket, cover, and screws. Tighten screws evenly in a crisscross manner.

Multipin Connector		
Connector Type	Mating Connector	Application
VT / VB	4-Pin, M12, Female, Single Keyway	DC
	4-Pin, M12, Female, Dual Reverse Keyway	AC
ZT / ZB	3-Pin, Mini, Female, Single Keyway	AC / DC

- **DIN Plug Connector Kit No. K236034**

1. The open-frame solenoid is provided with DIN terminals to accommodate the plug connector kit.
2. Remove center screw from plug connector. Using a small screwdriver, pry terminal block from connector cover.
3. Use #12-18 AWG stranded copper wire rated at 90°C or greater for connections. Strip wire leads back approximately 1/4" for installation in socket terminals. The use of wire-end sleeves is also recommended for these socket terminals. Maximum length of wire-end sleeves to be approximately 1/4". Tinning of the ends of the lead wires is not recommended.
4. Thread wire through gland nut, gland gasket, washer and connector cover.

NOTE: Connector housing may be rotated in 90° increments from position shown for alternate positioning of cable entry.

5. Check DIN connector terminal block for electrical markings. Then make electrical hookup to terminal block according to markings on it. Snap terminal block into connector cover and install center screw.
6. Position connector gasket on solenoid and install plug connector. Torque center screw to 5 ± 1 in-lbs [$0,6\pm 1,1$ Nm].

NOTE: Alternating current (AC) and direct current (DC) solenoids are built differently and cannot be converted from one to the other by changing the coil.

Installation of Solenoid

Solenoids may be assembled as a complete unit. Tightening is accomplished by means of a hex flange at the base of the solenoid.

Installation of Panel Mounted Solenoid (See Figures 1 and 2)

1. Disassemble solenoid following instruction under *Solenoid Replacement* then proceed.
2. Install solenoid base sub-assembly through customer panel. 8202H panel mounted solenoids include a retainer to adapt the solenoid base sub-assembly to the customer panel. (See Figure 2)
3. Position finger washer on opposite side of panel over solenoid base sub-assembly.
4. Replace solenoid, nameplate/retainer and red cap.
5. Make electrical hookup, see *Wiring* section.

Solenoid Temperature

Standard solenoids are designed for continuous duty service. When the solenoid is energized for a long period, the solenoid becomes hot and can be touched by hand only for an instant. This is a safe operating temperature.

MAINTENANCE

▲ WARNING: To prevent the possibility of death, serious injury or property damage, turnoff electrical power, depressurize solenoid operator and/or valve, and vent fluid to a safe area before servicing.

▲ AVERTISSEMENT: Pour éviter tous danger de mort, de blessure grave ou de dommage matériel, avant d'intervenir sur la vanne, couper le courant, purger la vanne dans une zone sécurisée.

Cleaning

All solenoid operators and valves should be cleaned periodically. The time between cleaning will vary depending on medium and service conditions. In general, if the voltage to the solenoid is correct, sluggish valve operation, excessive noise or leakage will indicate that cleaning is required. Clean strainer or filter when cleaning the valve.

Preventive Maintenance

- Keep the medium flowing through the solenoid operator or valve as free from dirt and foreign material as possible.
- Periodic exercise of the valve should be considered if ambient or fluid conditions are such that corrosion, elastomer degradation, fluid contamination build up, or other conditions that could impede solenoid valve shifting are possible. The actual frequency of exercise necessary will depend on specific operating conditions. A successful operating history is the best indication of a proper interval between exercise cycles.
- Depending on the medium and service conditions, periodic inspection of internal valve parts for damage or excessive wear is recommended. Thoroughly clean all parts. Replace any worn or damaged parts.

Page 3 of 6

©ASCO Valve, Inc. 50 Hanover Road, Florham Park, New Jersey 07932

Causes of Improper Operation

- **Faulty Control Circuit:** Check the electrical system by energizing the solenoid. A metallic *click* signifies that the solenoid is operating. Absence of the *click* indicates loss of power supply. Check for loose or blown fuses, open-circuited or grounded solenoid, broken leadwires or splice connections.
- **Burned-Out Solenoid:** Check for open-circuited solenoid. Replace if necessary. Check supply voltage; it must be the same as specified on nameplate/retainer and marked on the solenoid. Check ambient temperature and check that the core is not jammed.
- **Low Voltage:** Check voltage across the solenoid leads. Voltage must be at least 85% of rated voltage.

Solenoid Replacement

1. Disconnect conduit, coil leads, and grounding wire.

NOTE: Any optional parts attached to the old solenoid must be reinstalled on the new solenoid. For 3-way construction, piping or tubing must be removed from pipe adapter.

2. Disassemble solenoids with optional features as follows:

- **Spade or Screw Terminals**

Remove terminal connections, grounding screw, grounding wire, and terminal block (screw terminal type only).

NOTE: For screw terminals, the socket head screw holding the terminal block serves as a grounding screw.

- **Junction Box**

Remove conduit and socket head screw (use 5/32" hex key wrench) from center of junction box. Disconnect junction box from solenoid.

- **DIN Plug Connector**

Remove center screw from DIN plug connector. Disconnect DIN plug connector from adapter. Remove socket head screw (use 5/32" hex key wrench), DIN terminal adapter, and gasket from solenoid.

3. Remove red cap or retainer from top of solenoid base sub-assembly. For 3-way construction with pipe adapter (Figure 3), remove pipe adapter, nameplate and solenoid. Omit steps 4 and 5.
4. Push down on solenoid. Then using a suitable screwdriver, insert blade between solenoid and nameplate/retainer. Pry up slightly and push to remove. **NOTE:** Series 8202G/H solenoids have a spacer between the nameplate/retainer and solenoid.
5. Remove solenoid from solenoid base sub-assembly.
6. Reassemble in reverse order of disassembly. Use exploded views for identification and placement of parts.
7. Torque pipe adapter to 90 inch-pounds maximum [10,2 Nm maximum]. Then make up piping or tubing to pipe adapter on solenoid.

Disassembly and Reassembly of Solenoids

1. Remove solenoid, see *Solenoid Replacement*.
2. Remove spring washer from solenoid base sub-assembly. For 3-way construction, remove pipe adapter and plugnut gasket.
3. Unscrew solenoid base sub-assembly from valve body.
4. Remove internal solenoid parts for cleaning or replacement. Use exploded views for identification and placement of parts.
5. If the solenoid is part of a valve, refer to basic valve installation and maintenance instructions for further disassembly.
6. Torque solenoid base sub-assembly and adapter to 175 ± 25 in-lbs [$19,8\pm 2,8$ Nm].

ORDERING INFORMATION FOR ASCO SOLENOIDS

When Ordering Solenoids for ASCO Solenoid Operators or Valves, order the number stamped on the solenoid. Also specify voltage and frequency.

I&M No. V 6584 R19 sec1

www.ascovalve.com

Torque Chart

Part Name	Torque Value in Inch-Pounds	Torque Value in Newton-Meters
solenoid base sub-assembly	175 ± 25	19,8 ± 2,8
pipe adapter	90 maximum	10,2 maximum

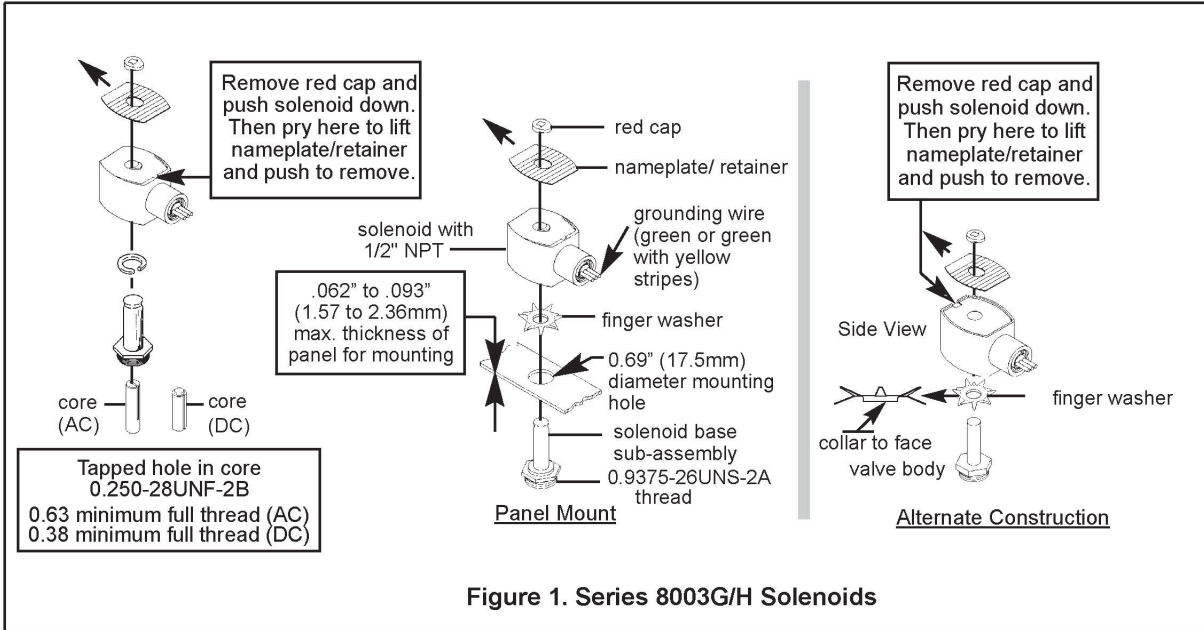

Figure 1. Series 8003G/H Solenoids

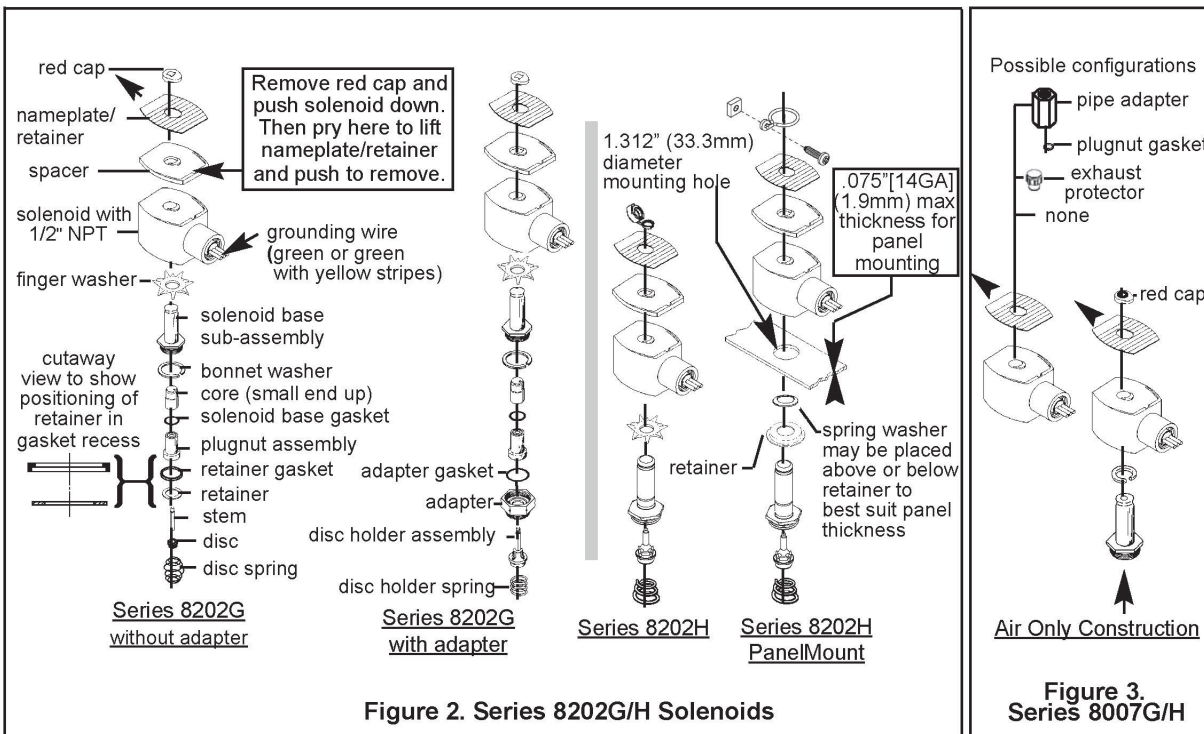

Figure 2. Series 8202G/H Solenoids

Figure 3. Series 8007G/H

I&M V 6584 R19 sec2

<h2 style="margin: 0;">Installation & Maintenance Instructions</h2> <p style="margin: 0;">OPEN-FRAME, GENERAL PURPOSE, WATERTIGHT/EXPLOSIONPROOF SOLENOIDS OPTIONAL FEATURE FOR OPEN FRAME (GENERAL PURPOSE) CONSTRUCTION ONLY</p>	<p style="margin: 0;">SERIES 8003G/H 8007G/H 8202G/H</p>
--	--

NOTICE: See Installation and Maintenance Instructions, I&M No. V_6584_R19 - Section 1 of 2 for detailed instructions.

Torque Chart

Part Name	Torque Value in Inch-Pounds	Torque Value in Newton-Meters
terminal block screws	10 ± 2	1,1 ± 0,2
socket head screw	15 - 20	1,7 - 2,3
center screw	5±1	0,6 ± 0,1

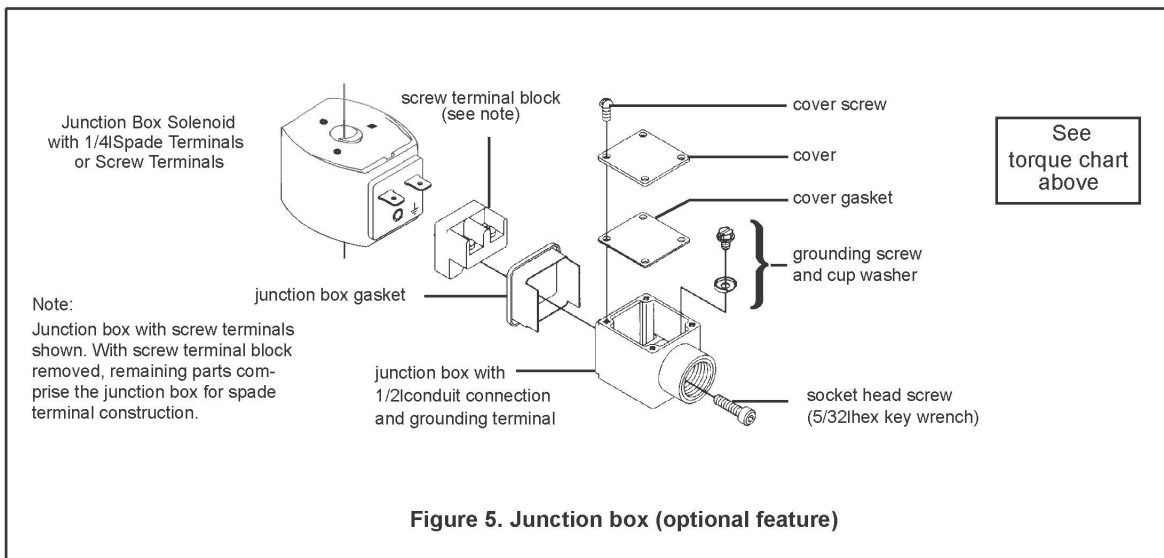
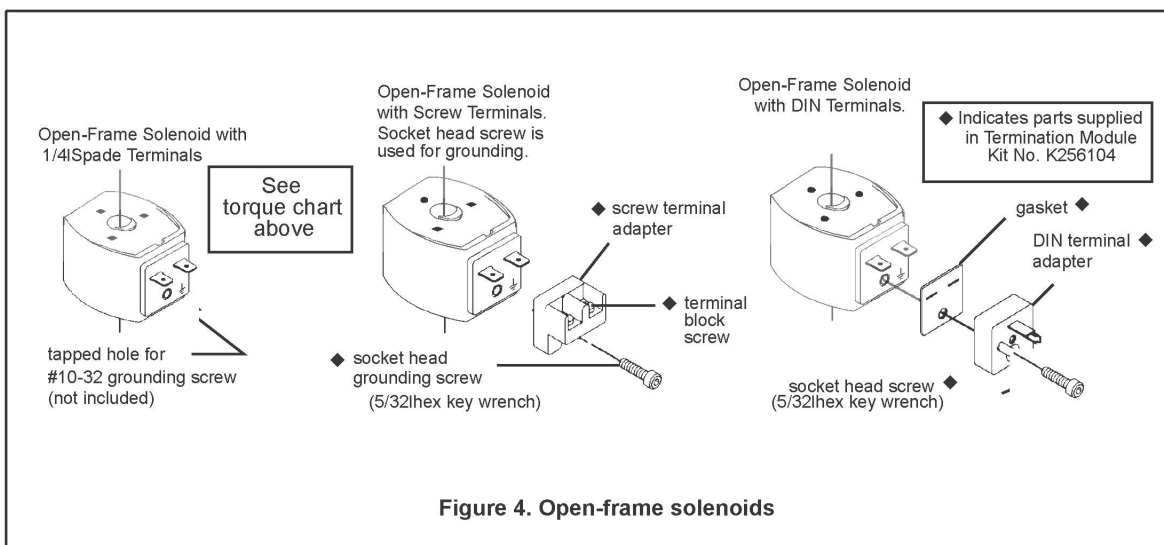

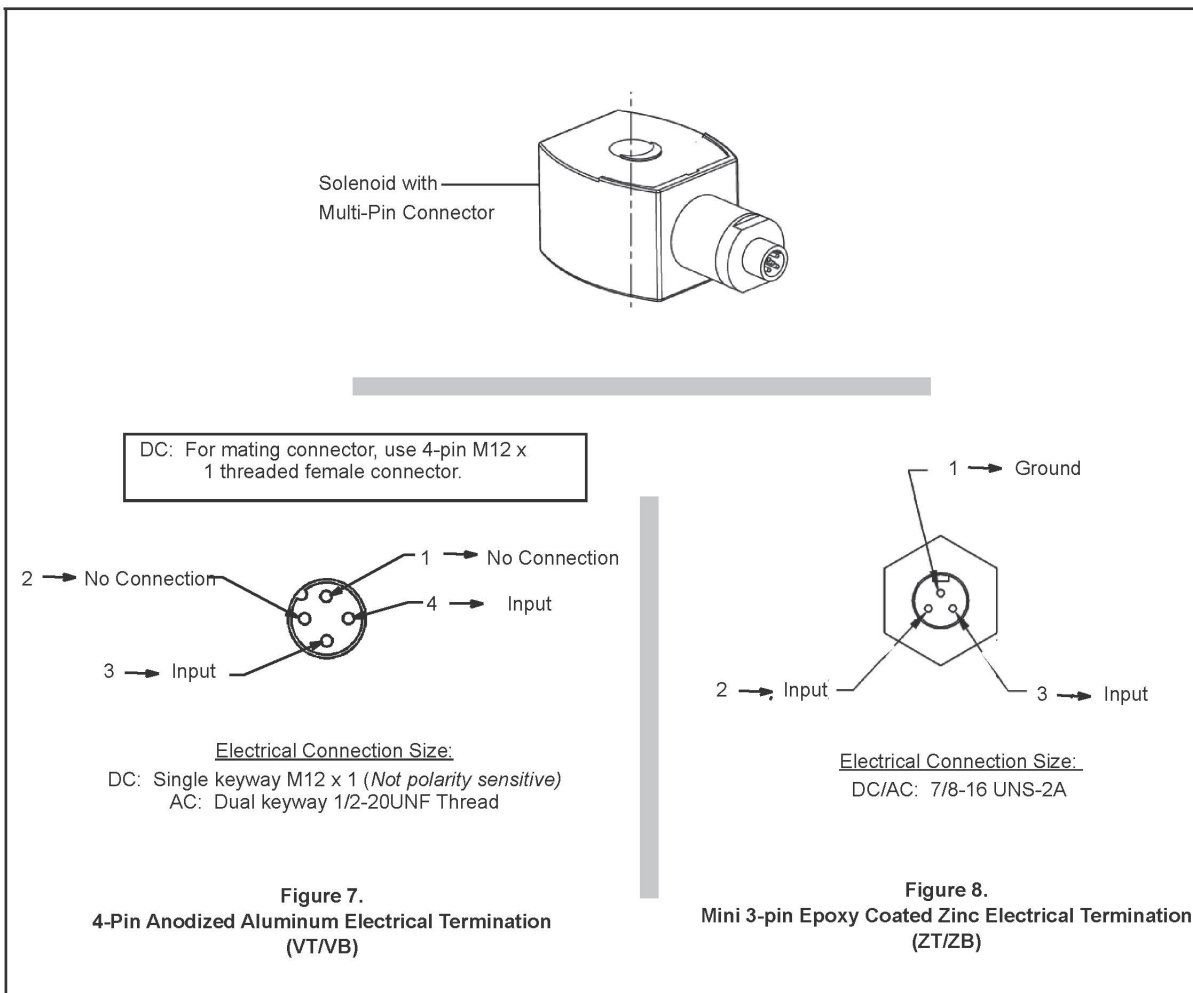
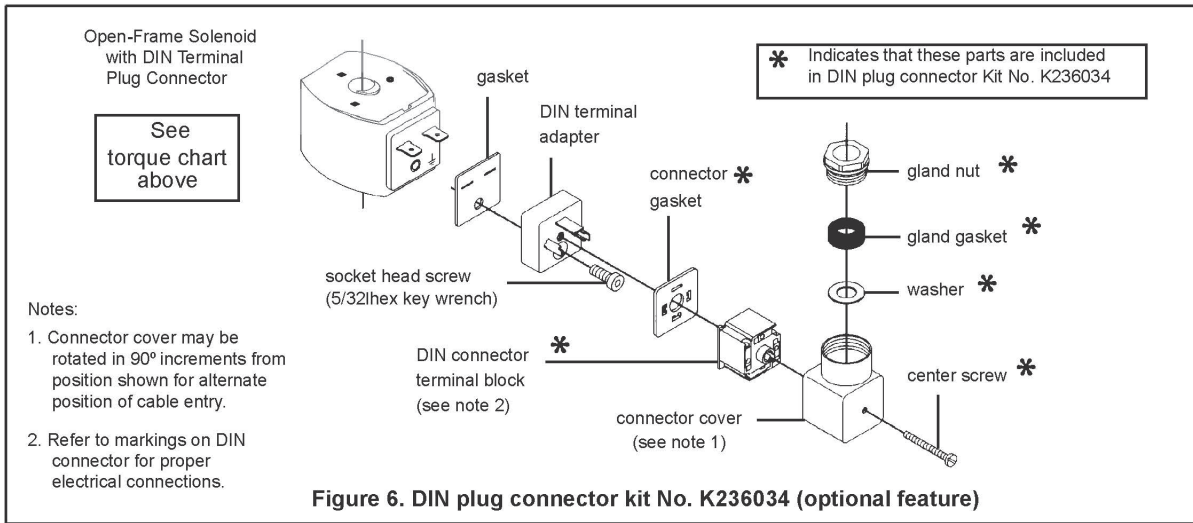

GLOSSARY

ABBREVIATIONS AND ACRONYMS

Term	Meaning
AC; ac	Alternating Current; strictly, electrical <i>current</i> that periodically reverses direction. Typically used also to describe an electrical power source in terms of the <i>voltage</i> . For example, 240 VAC.
ASCII	American Standard Code for Information Interchange; numerical representation of characters such as 'a' or '@' or an action (such as line-feed); 'plain' raw text with no formatting such as tabs, bold or underscoring
BNC connector	A miniature quick connect/disconnect RF connector used for coaxial cable, featuring two bayonet lugs on the female connector.
CR	Text Carriage-Return character
Cryogen	A substance for obtaining low temperatures. in the case of use with the Model 1700 instrument, a cryogen is a liquefied gas such as liquid nitrogen or liquid helium.
D-Sub	Term referring to the family of connectors containing an odd number of pins in two parallel rows with a 1-pin difference in pins-per-row (DB9, DB15, and DB25 are most common)
DB9	Type of electrical connector containing 9 pins arranged in two parallel rows of 4 pins and 5 pins each
DCE	Data Circuit-terminating Equipment - a device that sits between the Data Terminal Equipment (DTE) and a data transmission circuit.
DHCP	Dynamic Host Configuration Protocol; a computer networking protocol which dynamically distributes the IP address to networked devices
dt	Rate of change
DTE	Data Terminal Equipment - an end instrument that converts user information into signals or reconverts received signals. A DTE device communicates with the Data Circuit-terminating Equipment (DCE).

Term	Meaning
ECL	Electrical Connection Lubricant - also known as Dielectric Tune-up Grease, a protective lubricant that prevents corrosion.
E_o	Power supply output voltage
i, I	Electrical current flow
I_o	Power supply output current
IEC	International Electrotechnical Commission
IEEE	Institute of Electrical and Electronics Engineers
I/O	Input/Output; The hardware and associated protocol that implement communication between information processing systems and/or devices. Inputs are the signals or data received by the system or device, and outputs are the signals or data sent from it.
IP	Internet Protocol; when used with "address", refers to a numerical Internet address
kG	kilogauss: a magnetic field unit of measurement
LED	Light-Emitting Diode; a semiconductor device that emits light when energized - used for visual status indication
LHe	Liquid Helium
Max	Maximum
Min	Minimum
MSDS	Material Safety Data Sheet - provides workers and emergency personnel with procedures for handling or working with a specific substance in a safe manner and includes information such as physical data, toxicity, health effects, first aid, reactivity, storage, disposal, protective equipment, and spill-handling procedures.
RG-59/U	A specific type of coaxial cable, often used for low-power video and RF signal connections, with a characteristic impedance of 75 ohms.
R_{lead}	Electrical circuit lead or wiring resistance
RS-232	RS-232 is a long-established standard and protocol for relatively low speed serial data communication between computers and related devices; originally established for teletype-writer communication.
SCPI	Standard Commands for Programmable Instruments
V	Volts
VA	Volt-amperes ($V \times I$); a unit of electrical reactive power
V_{lead}	Voltage ($I \times R$) developed across circuit lead or wiring resistance due to current flow
V_m	Magnet voltage
V_s	Power supply voltage

A

abbreviations and acronyms 117

analog input

pin outs 99, 100

approximate calibration 64

autofill

standard 18

system setup 17

C

calibrating

approximate 64

closed dewar 59

methods 52

calibration

presetting MAX/MIN 59

closed dewar calibration 59

coaxial connectors, moisture protection 15

command

conventions 73

summary

system-related commands 74

command summary 73–77

Configuration, instrument xii

connecting

liquid helium sensors 15

connectors

RJ-45 - see Ethernet

cryogenic liquids viii

cryogenic liquids, first aid ix

E

ECL use 15

Ethernet

configuration

connector 79

termination characters 79

remote commands 80

remote port 7180 79

Ethernet connection pin out 98

F

first aid ix

front panel layout 6

I

installing

autofill system 17

capacitance sensors 12

earth ground xi

liquid helium sensors 13

mounting 11

power 20

unpacking 11

instrument description 1

Instrument part number definition xii

IP Address 78, 117

L

liquid helium sensor

connector J1 wiring 99

connector warning 15

lead wire sizing 16

sensor preparation
15

liquid level system terminology 117

M

menus 25

method of measurement 50

O

operation warnings xi, 11, 15, 20, 92, 93, 94

P

power on/off 23

power supply

operating characteristics 8

R

rear panel layout 7

remote commands

alarm configuration 83

assignment 87

display configuration 82

error codes 89

fill control 85

LHe calibration 88

LHe sampling 86

measurement 84

N2 calibration 87

system related 80

units 88

remote error codes 89

remote interface reference
 command summary 75, 76, 77

remote interface reference - see command

RJ-45 connector - see Ethernet

RS-232
 connector pin definitions 98
 pin out 97

RS-232 configuration
 parameters 77

S

safety
 cryogenic liquids viii
 equipment x
 legend x
 liquid helium sensor connectors 15
 warnings xi

Safety, cryogenics viii

sensor
 active length 48
 installation 12

sensor connector J1 wiring 99, 100

sensor physical parameters
 explanation 48

sensor transmitters
 calibration methods 52

sensor vent holes 48–49

serial communications
 commands 80
 factory reset 82
 interactive communication 73
 set date 81
 set time 82
 system reboot 82
 terminators 78

serial connector pin definitions 98

serial pin out 97

serial port connector/cables 78

system features 1

system specifications 8

V

vent holes 48–49

W

Warnings, equipment xi